

CORPORATION OF THE COUNTY OF BRUCE

BARROW BAY - BRUCE ROAD 9

PULVERIZE & PAVE

2026

BARROW BAY

CONTRACT No. RFT-BC-TES-26-10
 PROJECT No. TS-2024-004
 GL CODE 6-30-333-3405-9899

C.A.O.: CHRISTINE MACDONALD

CLERK: LINDA WHITE

DIRECTOR OF TRANSPORTATION & ENVIRONMENTAL SERVICES : ADAM STANLEY, C.Tech.

ENGINEERING MANAGER: RYAN ERRINGTON C.E.T.

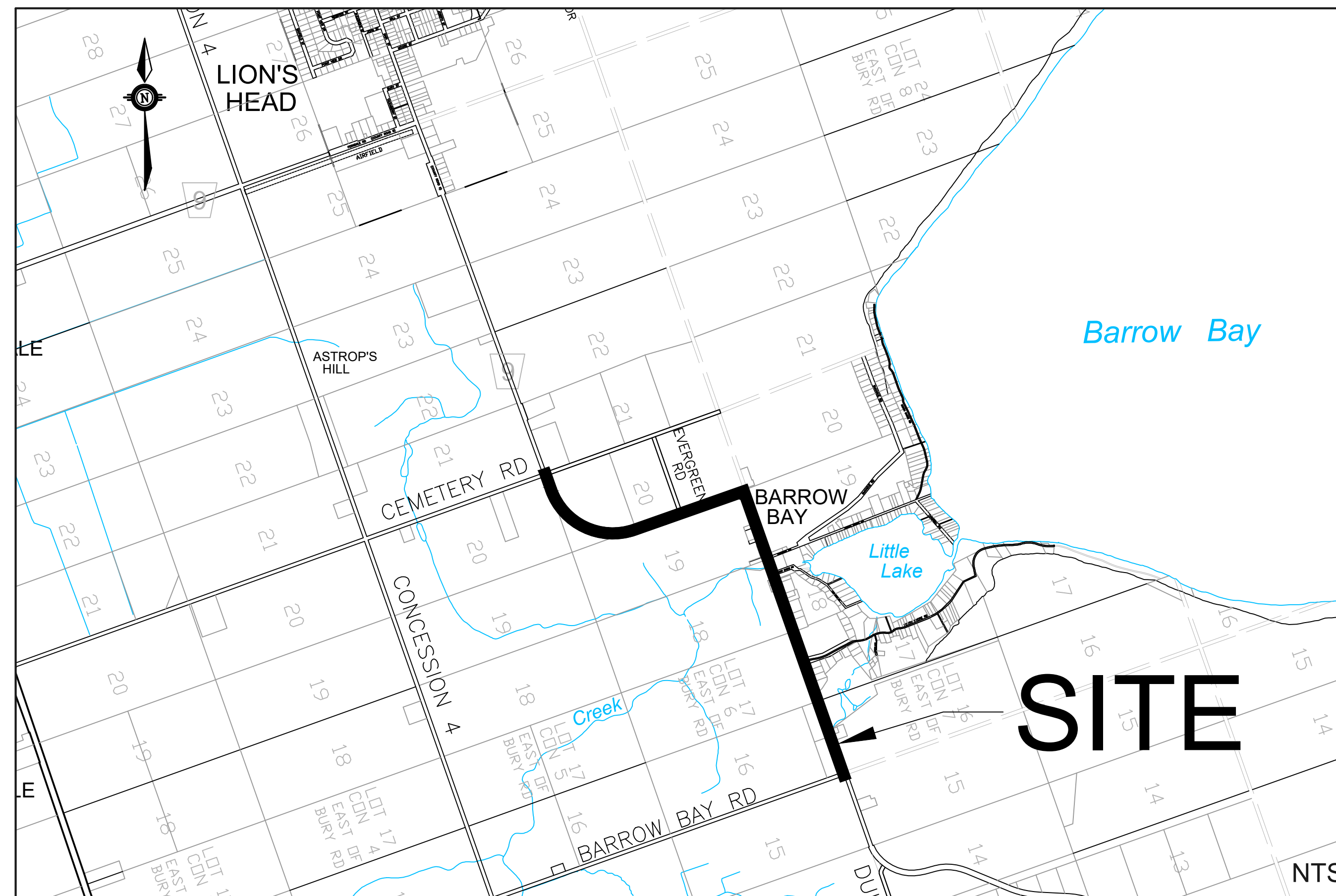

INDEX	
DRAWING NUMBER	DRAWING TITLE
PP00	TITLE PAGE
PP01	PLAN STA. 0+027 TO STA. 0+318
PP02	PLAN STA. 0+318 TO STA. 0+454
PP03	PLAN STA. 0+454 TO STA. 0+606
PP04	PLAN STA. 0+606 TO STA. 1+027
PP05	PLAN STA. 1+027 TO STA. 1+311
PP06	PLAN STA. 1+311 TO STA. 1+601
PP07	PLAN STA. 1+601 TO STA. 2+031
PP08	PLAN STA. 2+031 TO STA. 2+464
PP09	PLAN STA. 2+464 TO STA. 2+896
PP10	PLAN STA. 2+896 TO STA. 2+929
PP11	TYPICAL SECTIONS AND DETAILS 01
PP12	TYPICAL SECTIONS AND DETAILS 02

2026-01-27	ISSUED FOR TENDER
2025-11-25	FOR PRELIMINARY REVIEW
DATE	DESCRIPTION
	REVISION / ISSUE
Seal not valid unless signed and dated	
 BRUCE county	
Title: BRUCE ROAD 9 PULVERIZE & PAVE TITLE PAGE	
Client: CORPORATION OF THE COUNTY OF BRUCE	
Design: KNK	Scale: AS SHOWN
Drawn: KNK	Approved:
Checked: RME	
Date: 2026-01-27	Design Engineer
DRAWING No.	PP00

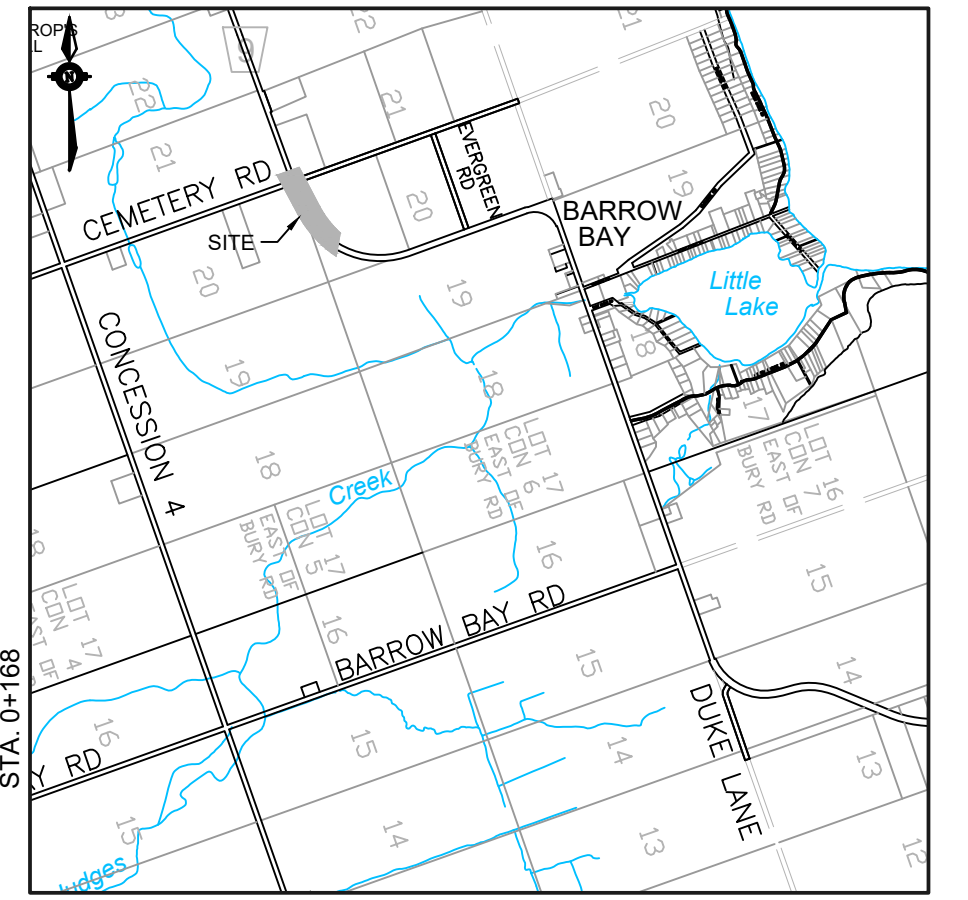
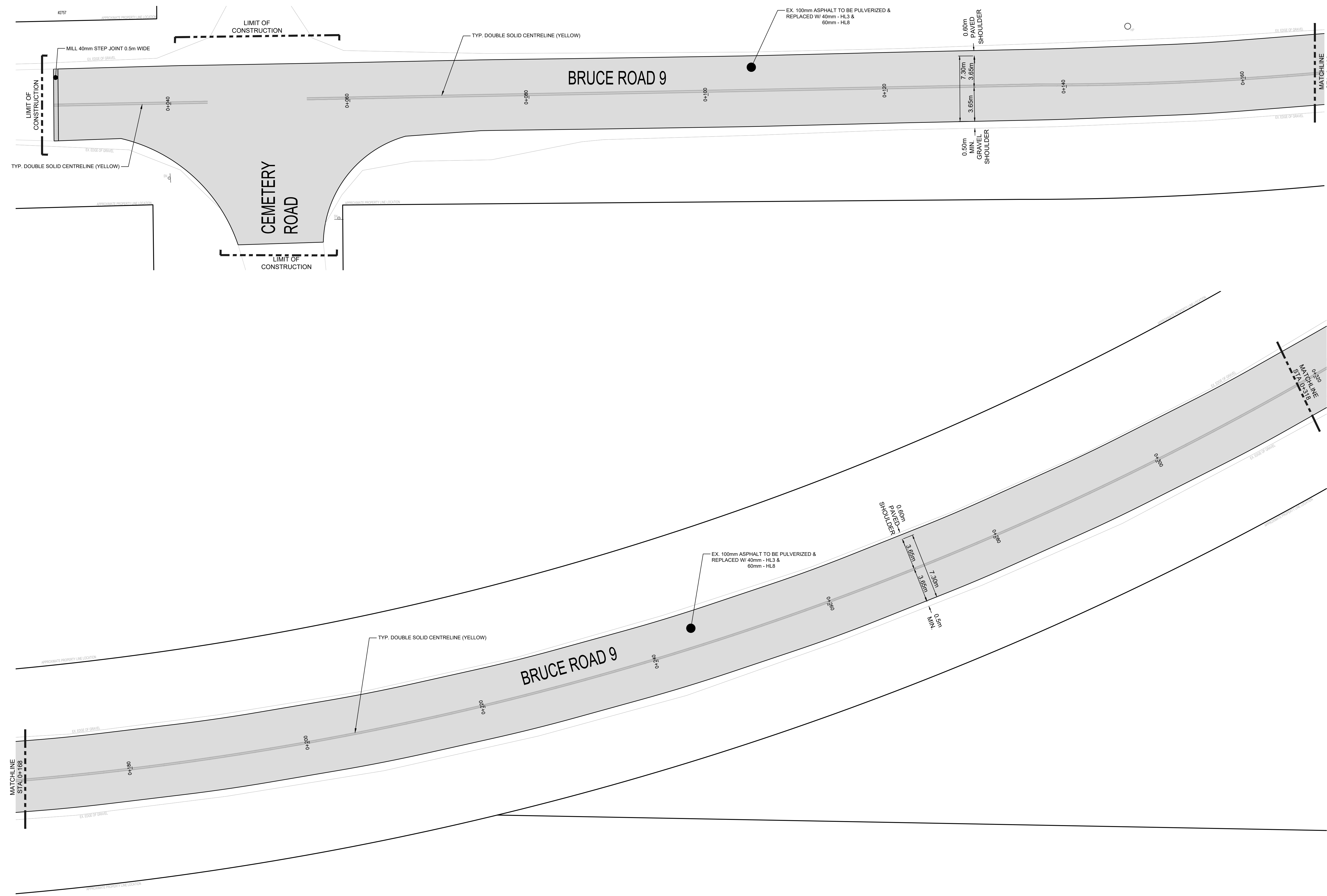
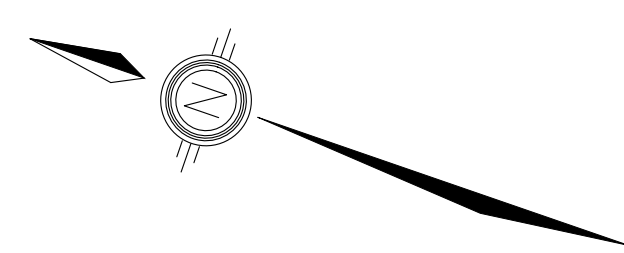

BRUCE COUNTY
KEY PLAN
NTS

LEGEND

	TREE REMOVAL/ AND OR TREE TRIMMING REQUIRED
	PROPOSED SANITARY SEWER
	EXISTING SANITARY SEWER
	PROPOSED STORM SEWER
	EXISTING STORM SEWER
	EXISTING WATERMAIN
	PROPOSED SANITARY SERVICE
	PROPOSED WATER SERVICE
	PROPOSED SANITARY MANHOLE
	EXISTING SANITARY MANHOLE
	PROPOSED CATCHBASIN MANHOLE
	PROPOSED DOUBLE CATCHBASIN MANHOLE
	PROPOSED DOUBLE CATCHBASIN
	PROPOSED CATCH BASIN
	EXISTING CATCH BASIN
	PROPOSED DITCH INLET CATCHBASIN
	PROPOSED SANITARY SERVICE CLEANOUT
	PROPOSED CURB STOP VALVE
	EXISTING CURB STOP VALVE
	EXISTING UNDERGROUND TELEPHONE CABLE
	EXISTING UNDERGROUND GAS LINE
	EXISTING UNDERGROUND HYDRO CABLE

CAUTION :
THE POSITION OF POLE LINES, CONDUITS, WATERMANS, SEWERS AND OTHER UNDERGROUND AND OVERGROUND UTILITIES AND STRUCTURES IS NOT NECESSARILY SHOWN ON THE CONTRACT DRAWINGS, AND, WHERE SHOWN, THE ACCURACY OF THE POSITION OF SUCH UTILITIES AND STRUCTURES IS NOT GUARANTEED. BEFORE STARTING WORK, THE CONTRACTOR SHALL INFORM HIMSELF OF THE EXACT LOCATION OF ALL SUCH UTILITIES AND STRUCTURES, AND SHALL ASSUME ALL LIABILITY FOR DAMAGE TO THEM.

2026-01-27	ISSUED FOR TENDER
2025-11-25	FOR PRELIMINARY REVIEW
DATE	DESCRIPTION
	REVISION / ISSUE

Seal not valid unless signed and dated



Title:
**BRUCE ROAD 9
PULVERIZE & PAVE
STA. 0+027 TO 0+318**

Client:
CORPORATION OF THE COUNTY OF BRUCE

Design: KNK	Scale: 1:200
Drawn: KNK	Approved:
Checked: RME	
Date: 2026-01-27	Design Engineer

DRAWING No. PP01

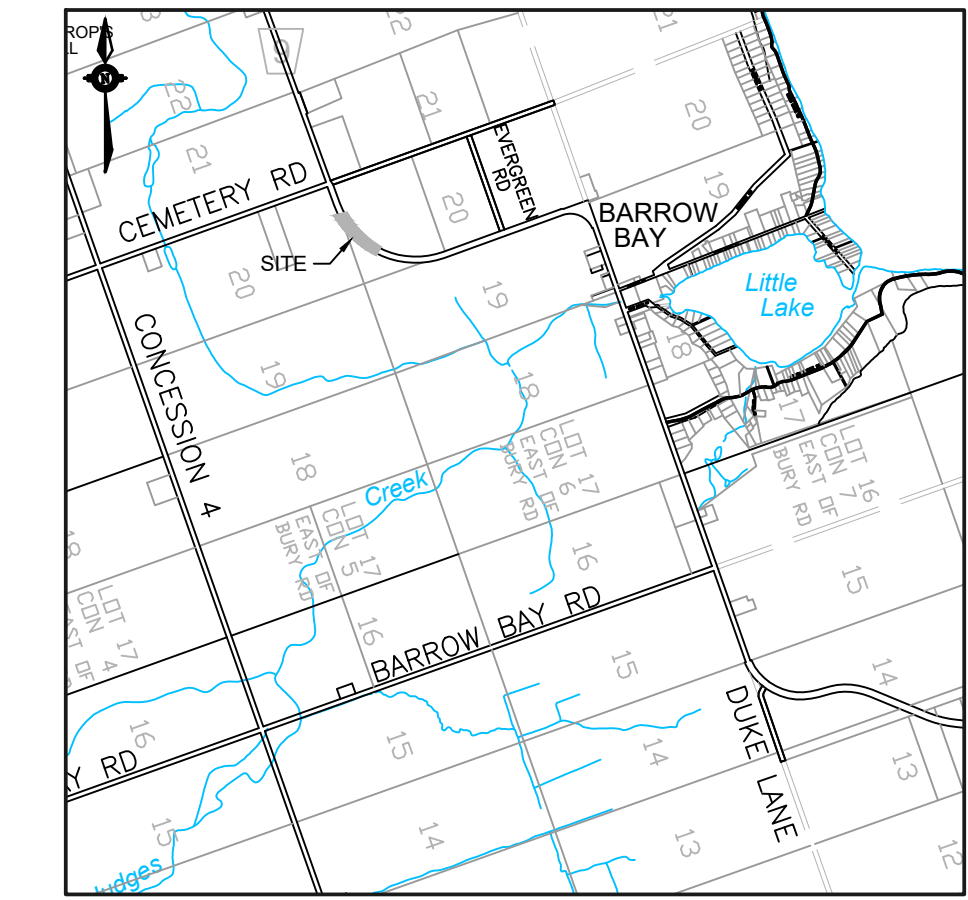
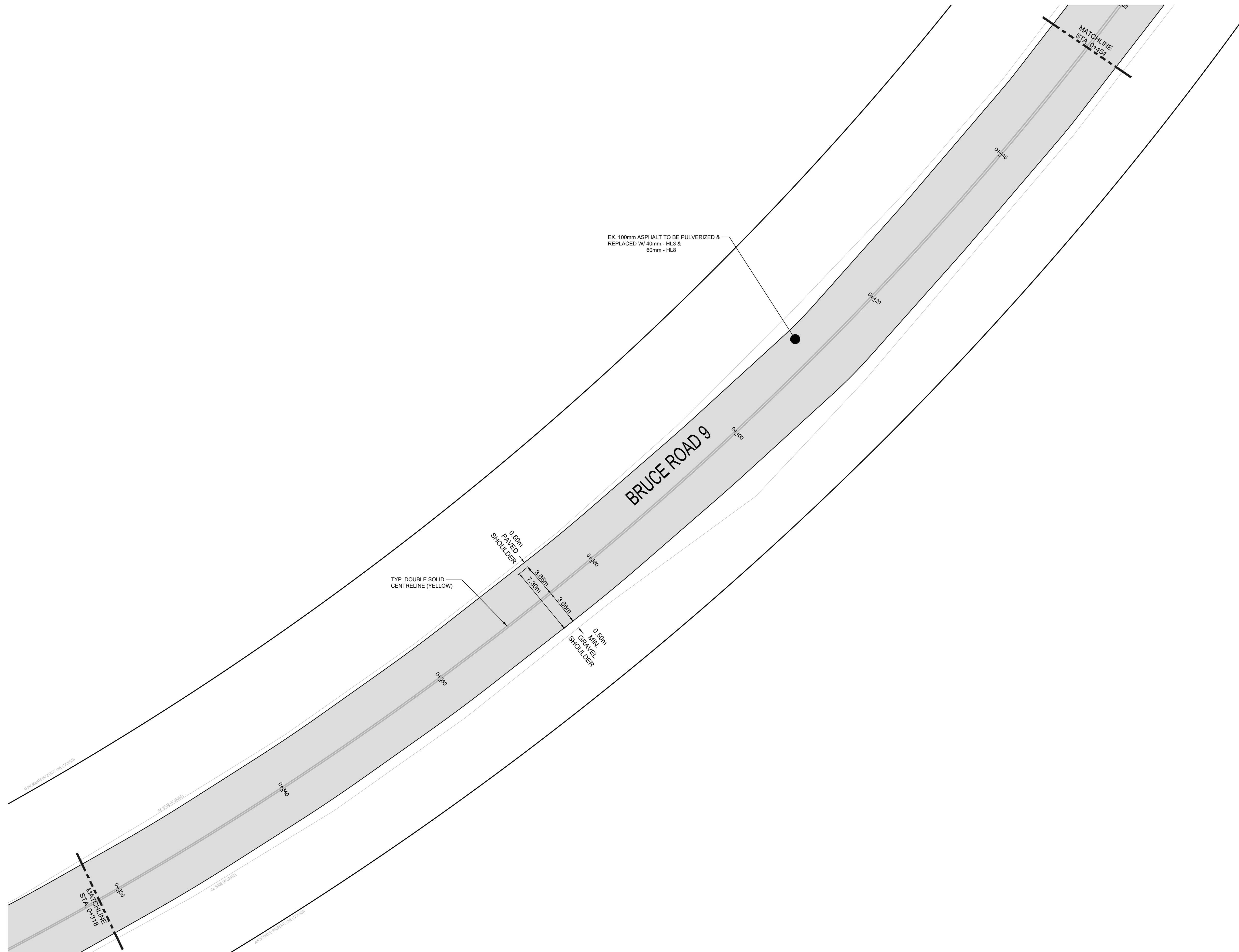
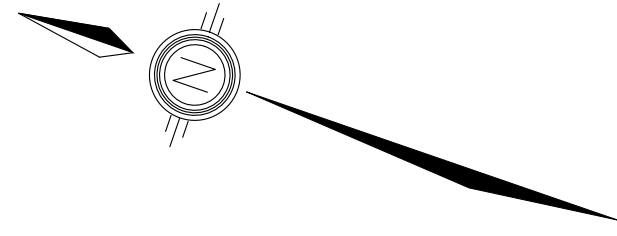

BRUCE COUNTY
KEY PLAN
NTS

LEGEND	
	TREE REMOVAL AND OR TREE TRIMMING REQUIRED
	PROPOSED SANITARY SEWER
	EXISTING SANITARY SEWER
	PROPOSED STORM SEWER
	EXISTING STORM SEWER
	EXISTING WATERMAIN
	PROPOSED SANITARY SERVICE
	PROPOSED WATER SERVICE
	SAN MH.1 PROPOSED SANITARY MANHOLE
	EX. SAN MH.1 EXISTING SANITARY MANHOLE
	CBMH PROPOSED CATCHBASIN MANHOLE
	DCBMH PROPOSED DOUBLE CATCHBASIN MANHOLE
	DCB PROPOSED DOUBLE CATCHBASIN
	CB PROPOSED CATCH BASIN
	EXCB EXISTING CATCH BASIN
	DICB PROPOSED DITCH INLET CATCHBASIN
	CO PROPOSED SANITARY SERVICE CLEANOUT
	CS PROPOSED CURB STOP VALVE
	EX. CS EXISTING CURB STOP VALVE
	T T EXISTING UNDERGROUND TELEPHONE CABLE
	GAS EXISTING UNDERGROUND GAS LINE
	H H EXISTING UNDERGROUND HYDRO CABLE

CAUTION :
THE POSITION OF POLE LINES, CONDUITS, WATERMANS, SEWERS AND OTHER UNDERGROUND AND OVERGROUND UTILITIES AND STRUCTURES IS NOT NECESSARILY SHOWN ON THE CONTRACT DRAWINGS, AND, WHERE SHOWN, THE ACCURACY OF THE POSITION OF SUCH UTILITIES AND STRUCTURES IS NOT GUARANTEED. BEFORE STARTING WORK, THE CONTRACTOR SHALL INFORM HIMSELF OF THE EXACT LOCATION OF ALL SUCH UTILITIES AND STRUCTURES, AND SHALL ASSUME ALL LIABILITY FOR DAMAGE TO THEM.

DATE	DESCRIPTION
2026-01-27	ISSUED FOR TENDER
2025-11-25	FOR PRELIMINARY REVIEW
	REVISION / ISSUE

Seal not valid unless signed and dated



Title:	
BRUCE ROAD 9 PULVERIZE & PAVE STA. 0+318 TO 0+454	
Client: CORPORATION OF THE COUNTY OF BRUCE	
Design: KNK	Scale: 1:200
Drawn: KNK	Approved:
Checked: RME	
Date: 2026-01-27	Design Engineer
DRAWING No.	PP02

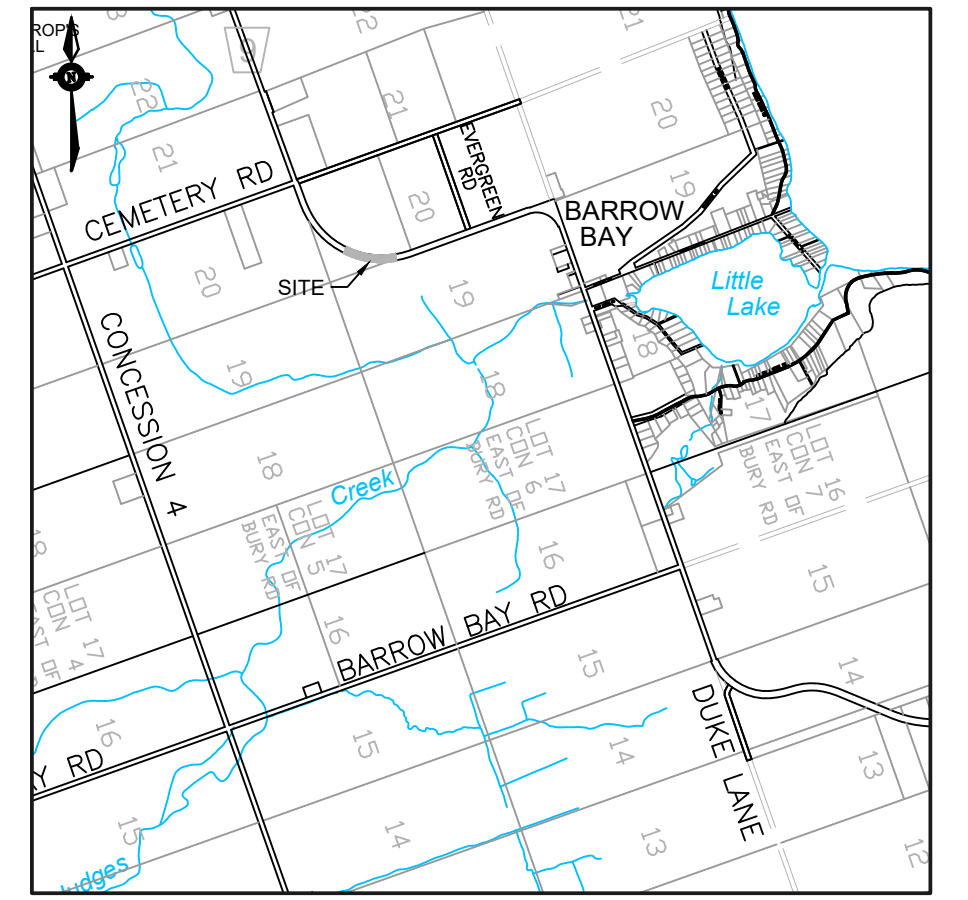
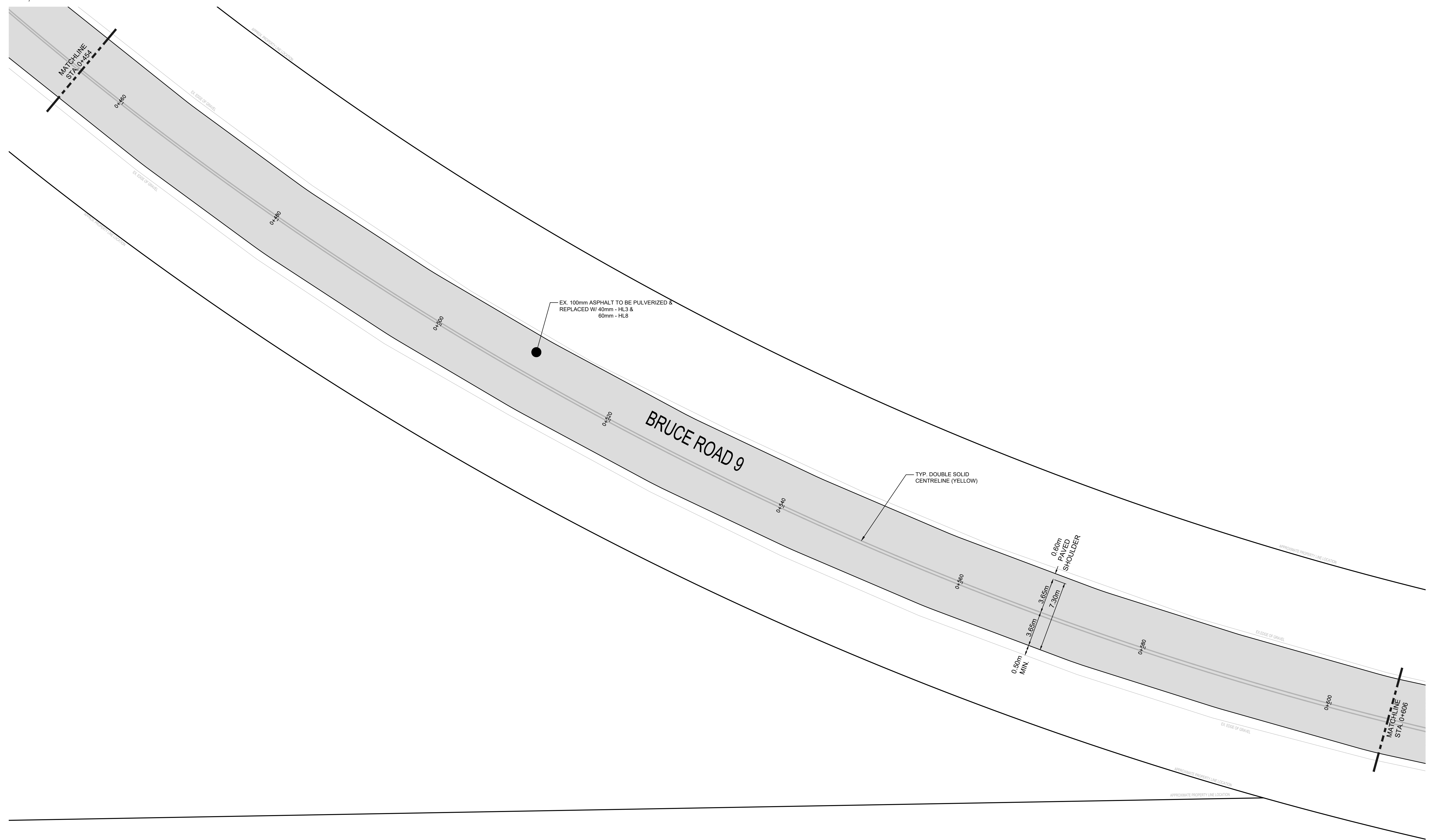
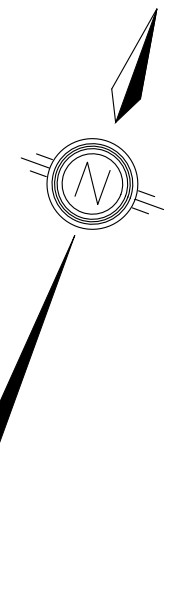

BRUCE COUNTY
KEY PLAN
NTS

LEGEND

	TREE REMOVAL AND OR TREE TRIMMING REQUIRED
	PROPOSED SANITARY SEWER
	EXISTING SANITARY SEWER
	PROPOSED STORM SEWER
	EXISTING STORM SEWER
	EXISTING WATERMAIN
	PROPOSED SANITARY SERVICE
	PROPOSED WATER SERVICE
	SAN MH.1
	PROPOSED SANITARY MANHOLE
	EXISTING SANITARY MANHOLE
	PROPOSED CATCHBASIN MANHOLE
	EXISTING CATCHBASIN MANHOLE
	DCBMH
	PROPOSED DOUBLE CATCHBASIN MANHOLE
	EXISTING DOUBLE CATCHBASIN MANHOLE
	DCB
	PROPOSED DOUBLE CATCHBASIN
	EXISTING DOUBLE CATCHBASIN
	EXCB
	PROPOSED CATCH BASIN
	EXISTING CATCH BASIN
	DICB
	PROPOSED DITCH INLET CATCHBASIN
	EXISTING DITCH INLET CATCHBASIN
	PROPOSED SANITARY SERVICE CLEANOUT
	EXISTING SANITARY SERVICE CLEANOUT
	PROPOSED CURB STOP VALVE
	EXISTING CURB STOP VALVE
	EXISTING UNDERGROUND TELEPHONE CABLE
	EXISTING UNDERGROUND GAS LINE
	EXISTING UNDERGROUND HYDRO CABLE

CAUTION :
THE POSITION OF POLE LINES, CONDUITS, WATERMANS, SEWERS AND OTHER UNDERGROUND AND OVERGROUND UTILITIES AND STRUCTURES IS NOT NECESSARILY SHOWN ON THE CONTRACT DRAWINGS, AND, WHERE SHOWN, THE ACCURACY OF THE POSITION OF SUCH UTILITIES AND STRUCTURES IS NOT GUARANTEED. BEFORE STARTING WORK, THE CONTRACTOR SHALL INFORM HIMSELF OF THE EXACT LOCATION OF ALL SUCH UTILITIES AND STRUCTURES, AND SHALL ASSUME ALL LIABILITY FOR DAMAGE TO THEM.

DATE	DESCRIPTION
2026-01-27	ISSUED FOR TENDER
2025-11-25	FOR PRELIMINARY REVIEW

Seal not valid unless signed and dated

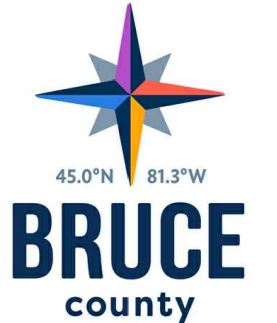

Title:
**BRUCE ROAD 9
PULVERIZE & PAVE
STA. 0+454 TO 0+606**

Client: CORPORATION OF THE COUNTY OF BRUCE	
Design: KNK	Scale: 1:200
Drawn: KNK	Approved:
Checked: RME	
Date: 2026-01-27	Design Engineer
DRAWING No.	PP03

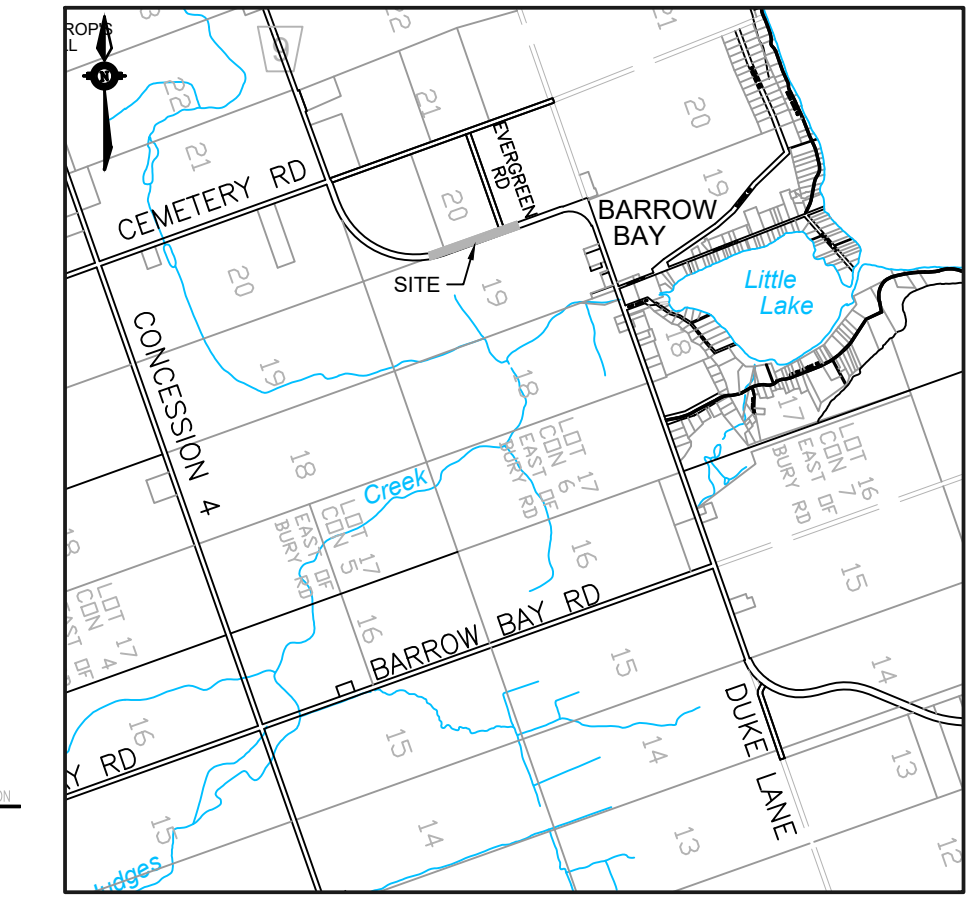
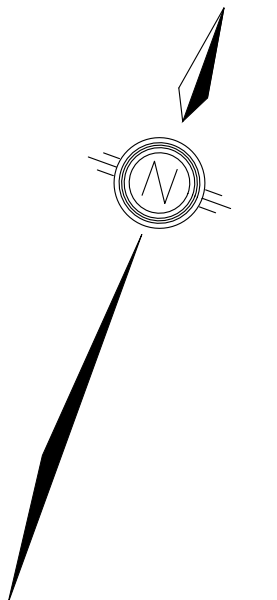

**BRUCE COUNTY
KEY PLAN
NTS**

LEGEND

	TREE REMOVAL/ AND OR TREE TRIMMING REQUIRED
	PROPOSED SANITARY SEWER
	EXISTING SANITARY SEWER
	PROPOSED STORM SEWER
	EXISTING STORM SEWER
	EXISTING WATERMAIN
	PROPOSED SANITARY SERVICE
	PROPOSED WATER SERVICE
	PROPOSED SANITARY MANHOLE
	EXISTING SANITARY MANHOLE
	PROPOSED CATCHBASIN MANHOLE
	EXISTING CATCHBASIN MANHOLE
	PROPOSED DOUBLE CATCHBASIN MANHOLE
	EXISTING DOUBLE CATCHBASIN MANHOLE
	PROPOSED DOUBLE CATCHBASIN
	EXISTING DOUBLE CATCHBASIN
	PROPOSED CATCH BASIN
	EXISTING CATCH BASIN
	PROPOSED DITCH INLET CATCHBASIN
	EXISTING DITCH INLET CATCHBASIN
	PROPOSED SANITARY SERVICE CLEANOUT
	EXISTING SANITARY SERVICE CLEANOUT
	PROPOSED CURB STOP VALVE
	EXISTING CURB STOP VALVE
	EXISTING UNDERGROUND TELEPHONE CABLE
	EXISTING UNDERGROUND GAS LINE
	EXISTING UNDERGROUND HYDRO CABLE

CAUTION :
THE POSITION OF POLE LINES, CONDUITS, WATERMANS, SEWERS AND OTHER UNDERGROUND AND OVERGROUND UTILITIES AND STRUCTURES IS NOT NECESSARILY SHOWN ON THE CONTRACT DRAWINGS, AND, WHERE SHOWN, THE ACCURACY OF THE POSITION OF SUCH UTILITIES AND STRUCTURES IS NOT GUARANTEED. BEFORE STARTING WORK, THE CONTRACTOR SHALL INFORM HIMSELF OF THE EXACT LOCATION OF ALL SUCH UTILITIES AND STRUCTURES, AND SHALL ASSUME ALL LIABILITY FOR DAMAGE TO THEM.

2026-01-27	ISSUED FOR TENDER
2025-11-25	FOR PRELIMINARY REVIEW
DATE	DESCRIPTION
	REVISION / ISSUE

Seal not valid unless signed and dated



Title:
**BRUCE ROAD 9
PULVERIZE & PAVE
STA. 0+606 TO 1+027**

Client: CORPORATION OF THE COUNTY OF BRUCE	
Design: KNK	Scale: 1:200
Drawn: KNK	Approved:
Checked: RME	
Date: 2026-01-27	Design Engineer
DRAWING No.	PP04

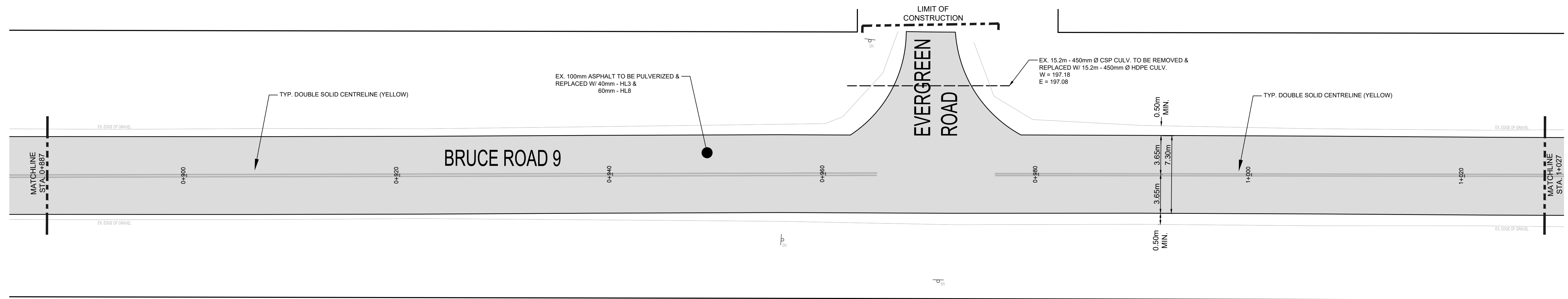
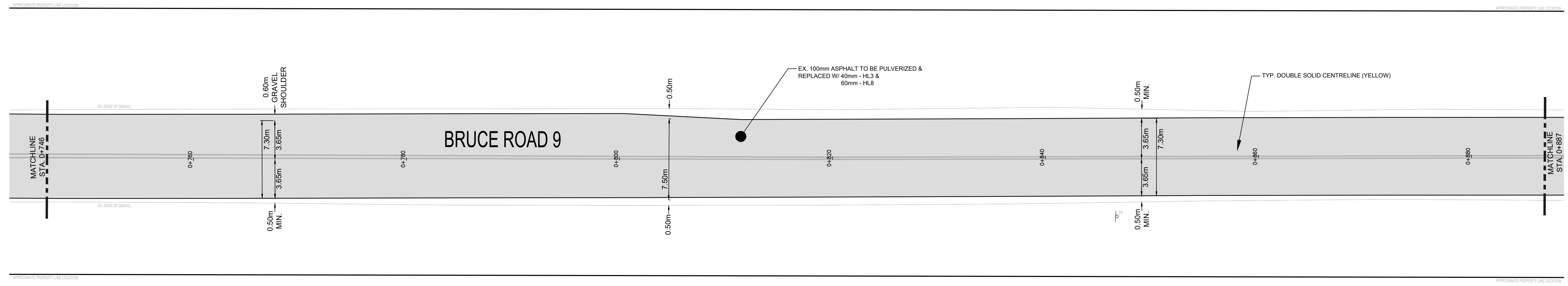
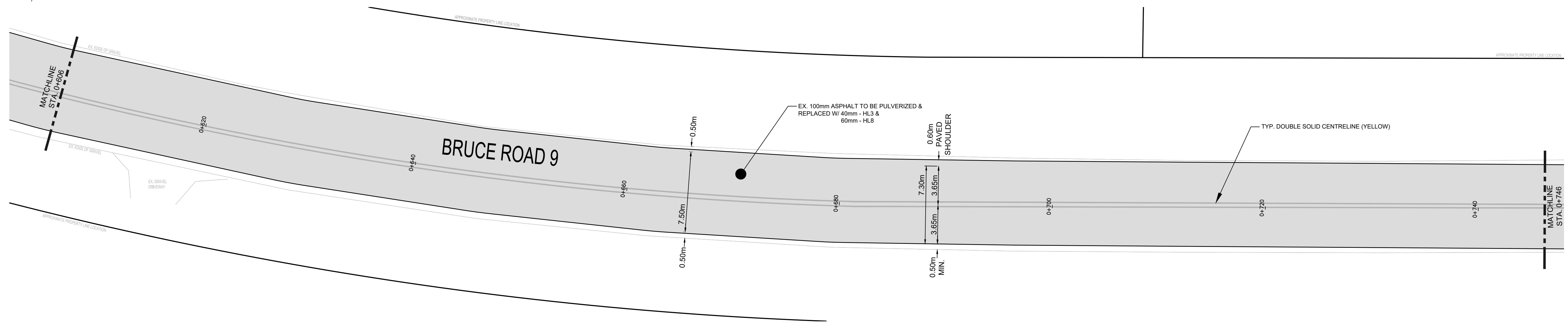

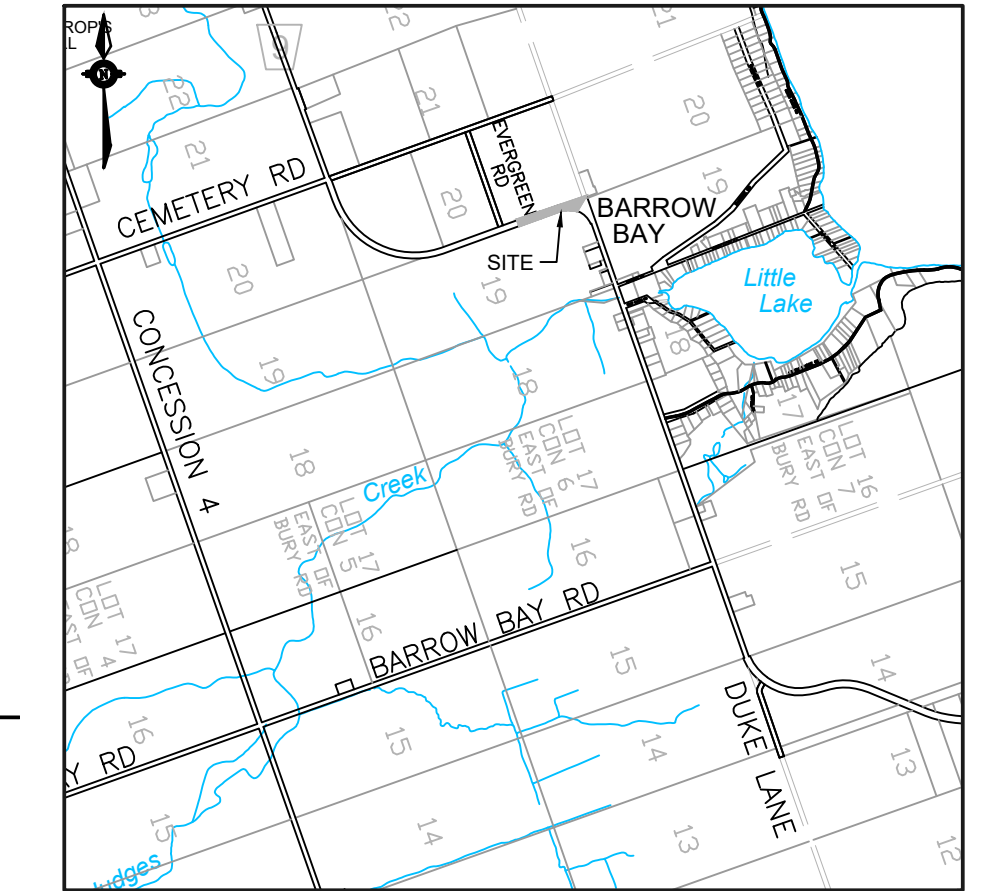
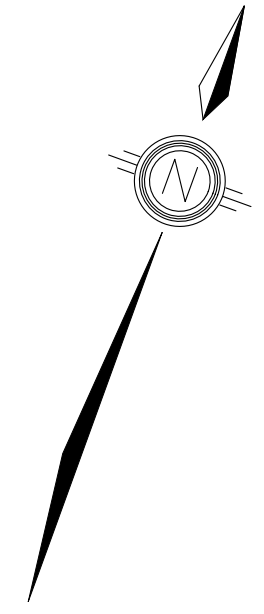

**BRUCE COUNTY
KEY PLAN
NTS**

LEGEND

	TREE REMOVAL/ AND OR TREE TRIMMING REQUIRED
	PROPOSED SANITARY SEWER
	EXISTING SANITARY SEWER
	PROPOSED STORM SEWER
	EXISTING STORM SEWER
	EXISTING WATERMAIN
	PROPOSED SANITARY SERVICE
	PROPOSED WATER SERVICE
	PROPOSED SANITARY MANHOLE
	EXISTING SANITARY MANHOLE
	PROPOSED CATCHBASIN MANHOLE
	PROPOSED DOUBLE CATCHBASIN MANHOLE
	PROPOSED DOUBLE CATCHBASIN
	PROPOSED CATCH BASIN
	EXISTING CATCH BASIN
	PROPOSED DITCH INLET CATCHBASIN
	PROPOSED SANITARY SERVICE CLEANOUT
	PROPOSED CURB STOP VALVE
	EXISTING CURB STOP VALVE
	EXISTING UNDERGROUND TELEPHONE CABLE
	EXISTING UNDERGROUND GAS LINE
	EXISTING UNDERGROUND HYDRO CABLE

CAUTION :
THE POSITION OF POLE LINES, CONDUITS, WATERMANS, SEWERS AND OTHER UNDERGROUND AND OVERGROUND UTILITIES AND STRUCTURES IS NOT NECESSARILY SHOWN ON THE CONTRACT DRAWINGS, AND, WHERE SHOWN, THE ACCURACY OF THE POSITION OF SUCH UTILITIES AND STRUCTURES IS NOT GUARANTEED. BEFORE STARTING WORK, THE CONTRACTOR SHALL INFORM HIMSELF OF THE EXACT LOCATION OF ALL SUCH UTILITIES AND STRUCTURES, AND SHALL ASSUME ALL LIABILITY FOR DAMAGE TO THEM.

2026-01-27	ISSUED FOR TENDER
2025-11-25	FOR PRELIMINARY REVIEW
DATE	DESCRIPTION
	REVISION / ISSUE

Seal not valid unless signed and dated



Title:
**BRUCE ROAD 9
PULVERIZE & PAVE
STA. 1+027 TO 1+311**

Client: CORPORATION OF THE COUNTY OF BRUCE	
Design: KNK	Scale: 1:200
Drawn: KNK	Approved:
Checked: RME	
Date: 2026-01-27	Design Engineer
DRAWING No.	PP05

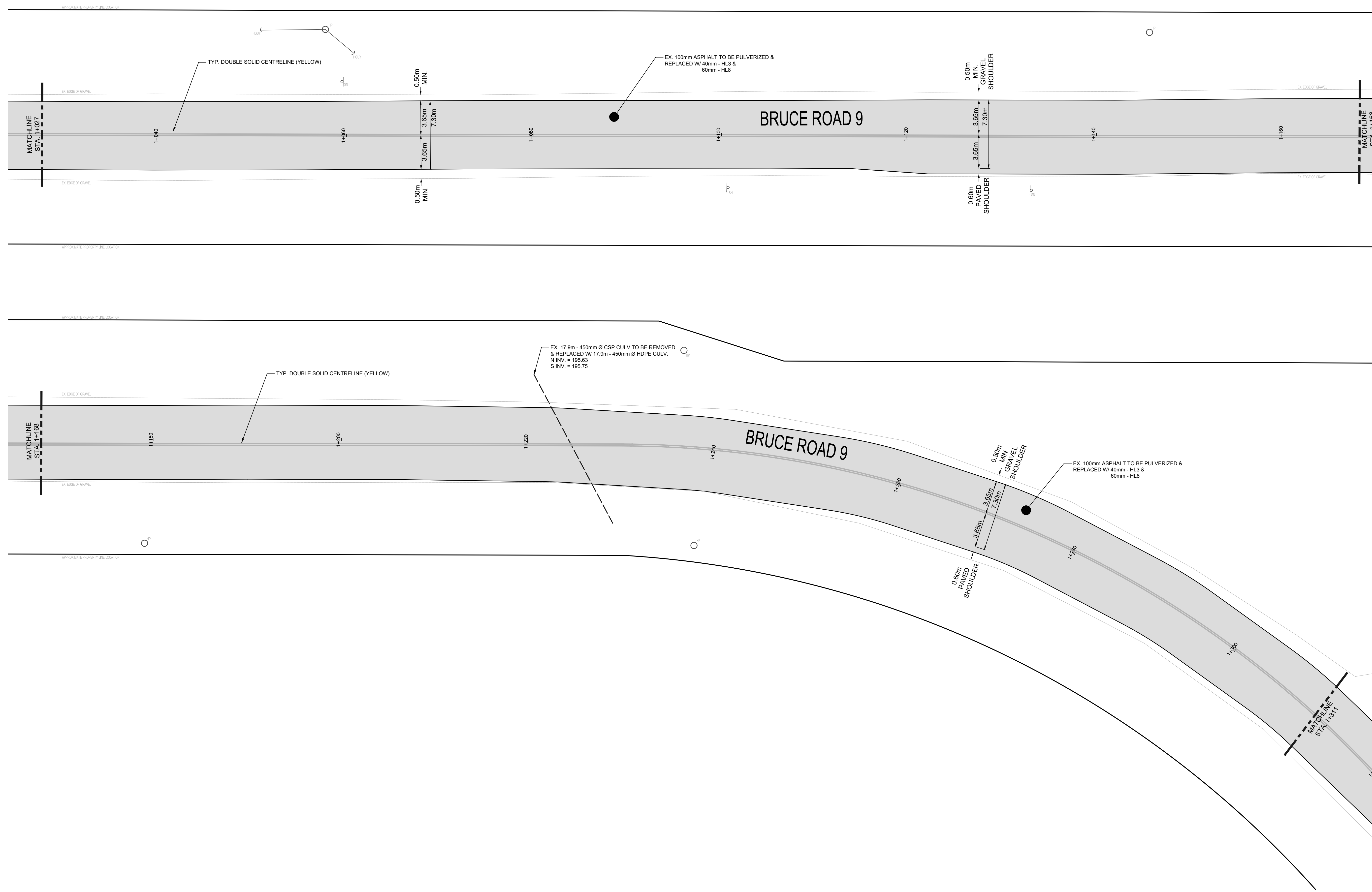

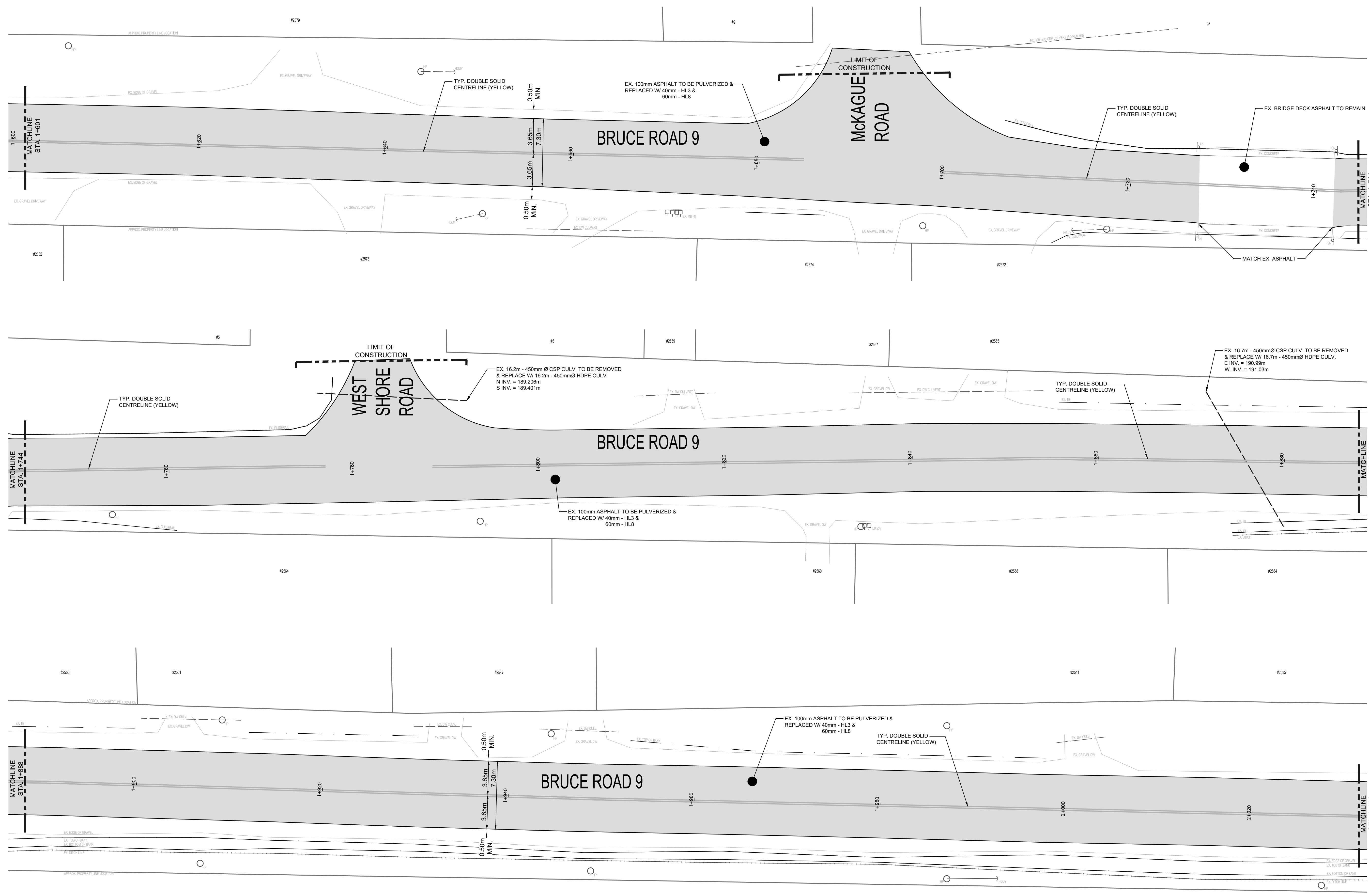
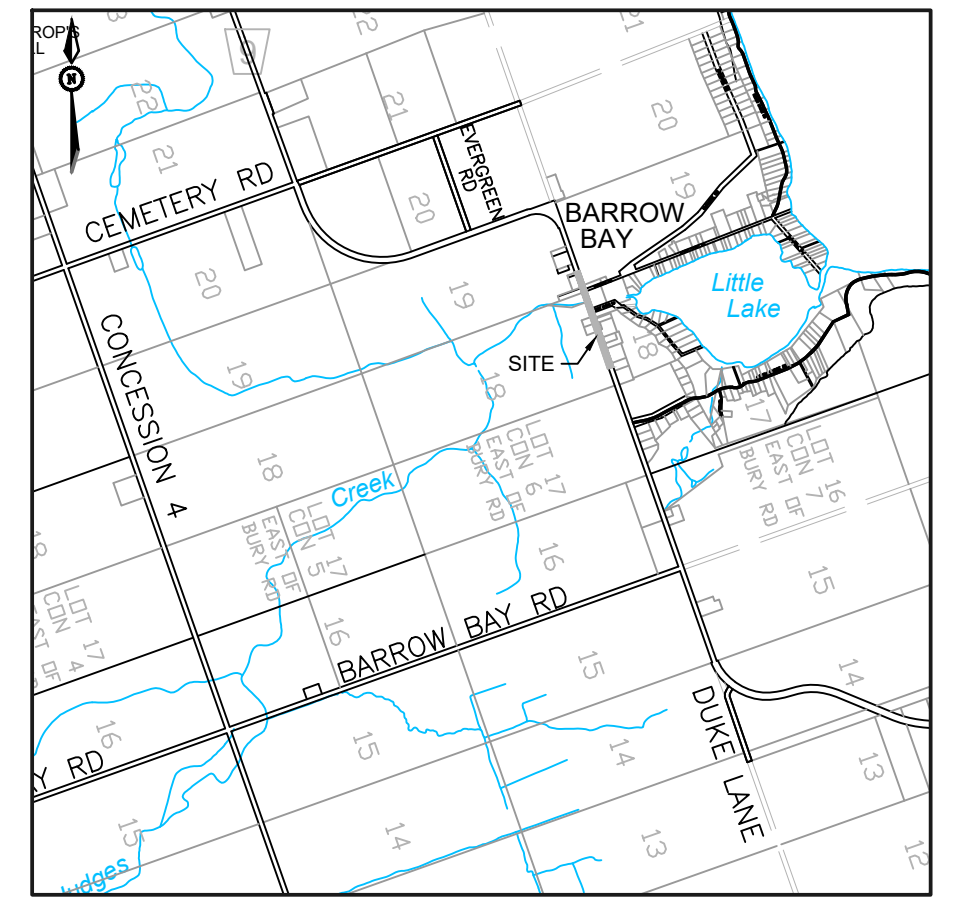
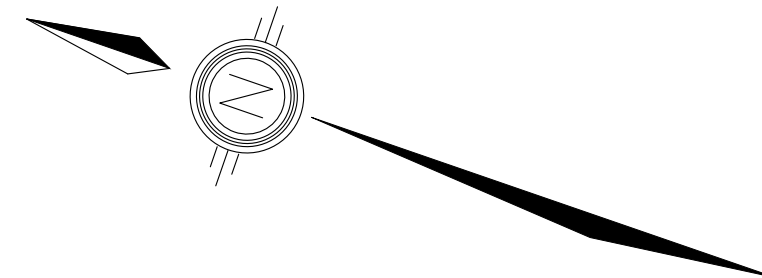

**BRUCE COUNTY
KEY PLAN
NTS**

LEGEND

	TREE REMOVAL AND OR TREE TRIMMING REQUIRED
	PROPOSED SANITARY SEWER
	EXISTING SANITARY SEWER
	PROPOSED STORM SEWER
	EXISTING STORM SEWER
	EXISTING WATERMAIN
	PROPOSED SANITARY SERVICE
	PROPOSED WATER SERVICE
	PROPOSED SANITARY MANHOLE
	EXISTING SANITARY MANHOLE
	PROPOSED CATCHBASIN MANHOLE
	EXISTING CATCHBASIN MANHOLE
	PROPOSED DOUBLE CATCHBASIN MANHOLE
	EXISTING DOUBLE CATCHBASIN MANHOLE
	PROPOSED CATCH BASIN
	EXISTING CATCH BASIN
	PROPOSED DITCH INLET CATCHBASIN
	EXISTING DITCH INLET CATCHBASIN
	PROPOSED SANITARY SERVICE CLEANOUT
	PROPOSED CURB STOP VALVE
	EXISTING CURB STOP VALVE
	EXISTING UNDERGROUND TELEPHONE CABLE
	EXISTING UNDERGROUND GAS LINE
	EXISTING UNDERGROUND HYDRO CABLE

CAUTION :
THE POSITION OF POLE LINES, CONDUITS, WATERMANS, SEWERS AND OTHER UNDERGROUND AND OVERGROUND UTILITIES AND STRUCTURES IS NOT NECESSARILY SHOWN ON THE CONTRACT DRAWINGS, AND, WHERE SHOWN, THE ACCURACY OF THE POSITION OF SUCH UTILITIES AND STRUCTURES IS NOT GUARANTEED. BEFORE STARTING WORK, THE CONTRACTOR SHALL INFORM HIMSELF OF THE EXACT LOCATION OF ALL SUCH UTILITIES AND STRUCTURES, AND SHALL ASSUME ALL LIABILITY FOR DAMAGE TO THEM.

2026-01-27	ISSUED FOR TENDER
2025-11-25	FOR PRELIMINARY REVIEW
DATE	DESCRIPTION
	REVISION / ISSUE

Seal not valid unless signed and dated



Title:
**BRUCE ROAD 9
PULVERIZE & PAVE
STA. 1+601 TO 2+031**

Client: CORPORATION OF THE COUNTY OF BRUCE	
Design: KNK	Scale: 1:200
Drawn: KNK	Approved:
Checked: RME	
Date: 2026-01-27	Design Engineer
DRAWING No.	PP07

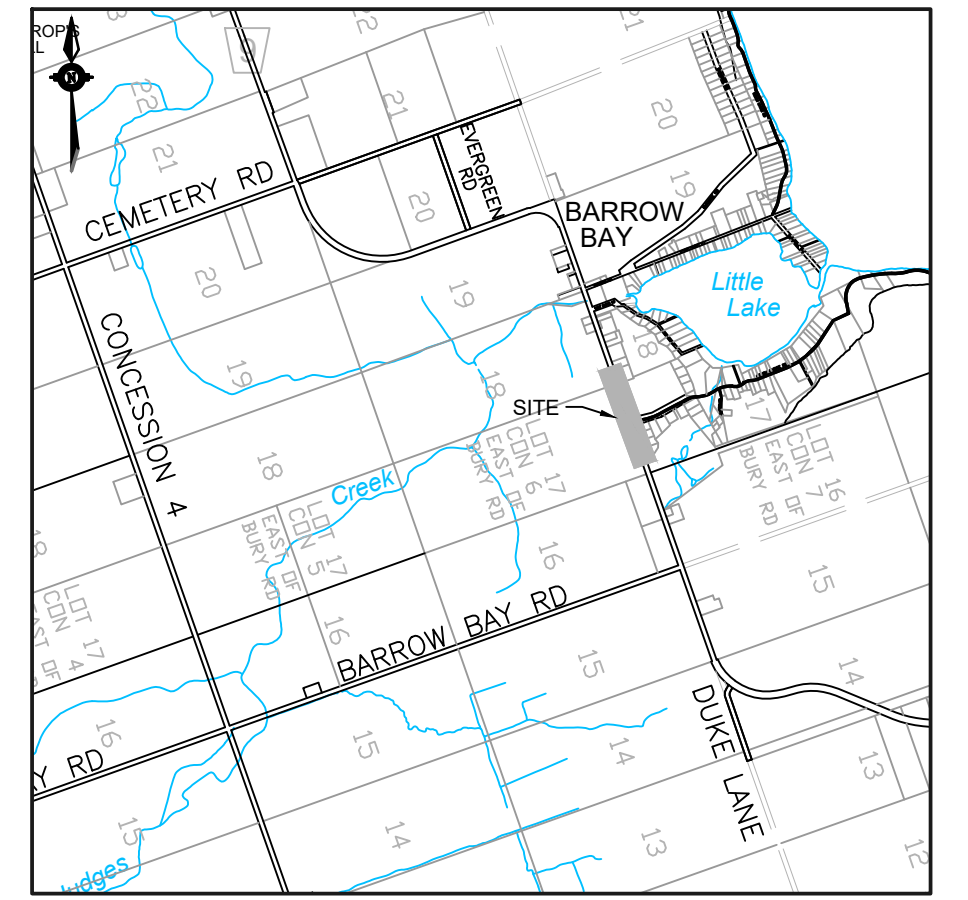
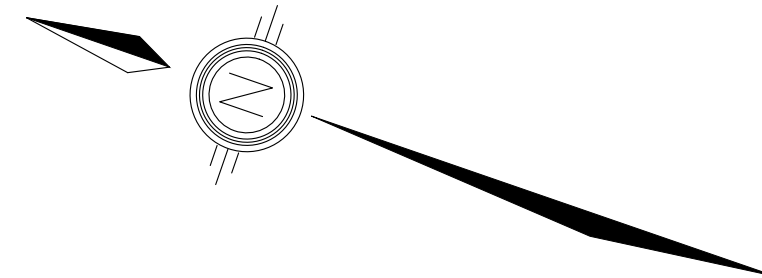

**BRUCE COUNTY
KEY PLAN
NTS**

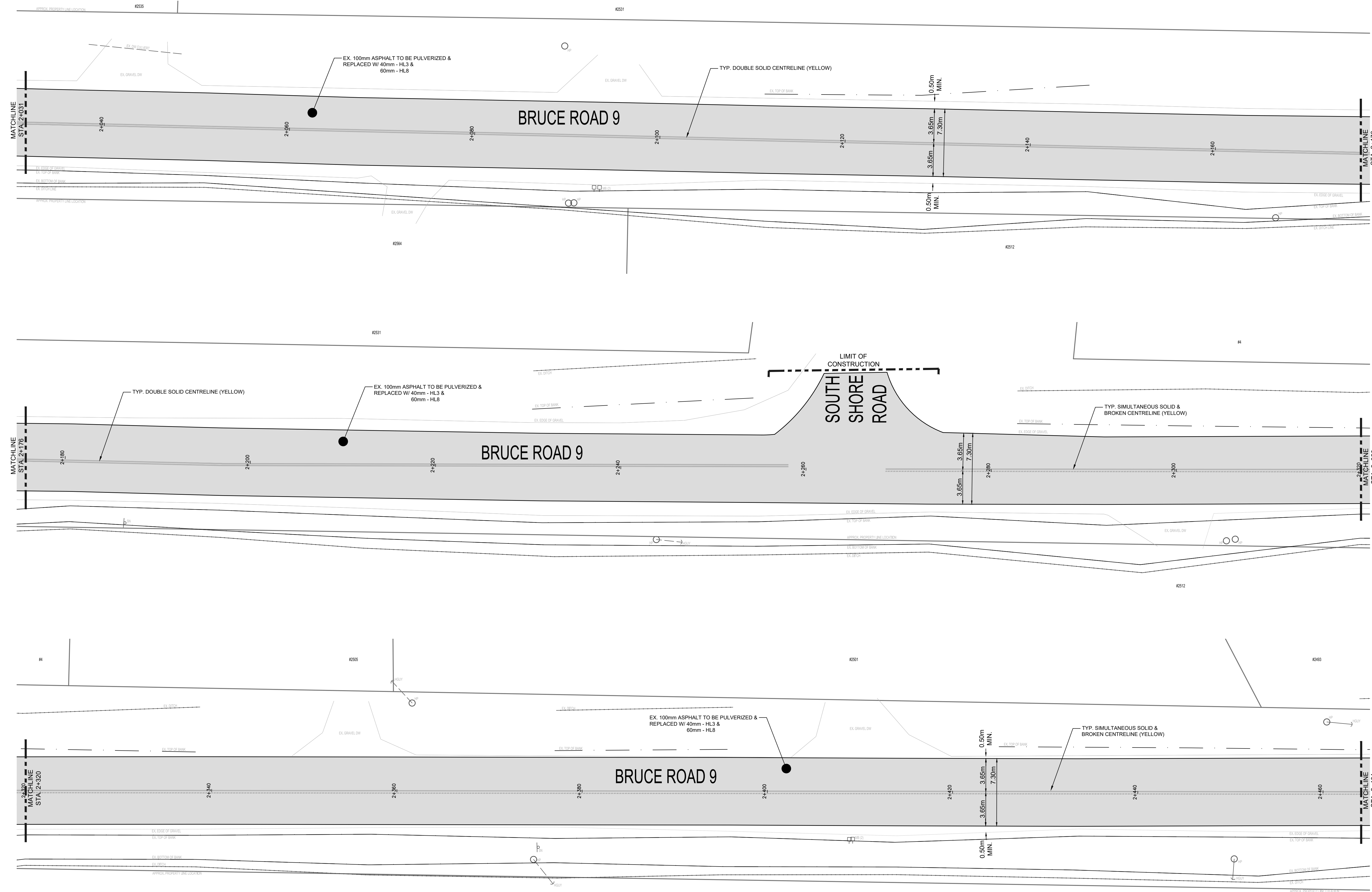

LEGEND

	TREE REMOVAL/ AND OR TREE TRIMMING REQUIRED
	PROPOSED SANITARY SEWER
	EXISTING SANITARY SEWER
	PROPOSED STORM SEWER
	EXISTING STORM SEWER
	EXISTING WATERMAIN
	PROPOSED SANITARY SERVICE
	PROPOSED WATER SERVICE
	SAN MH.1
	PROPOSED SANITARY MANHOLE
	EXISTING SANITARY MANHOLE
	PROPOSED CATCHBASIN MANHOLE
	EXISTING CATCHBASIN MANHOLE
	PROPOSED DOUBLE CATCHBASIN MANHOLE
	EXISTING DOUBLE CATCHBASIN MANHOLE
	PROPOSED CATCH BASIN
	EXISTING CATCH BASIN
	PROPOSED DITCH INLET CATCHBASIN
	EXISTING DITCH INLET CATCHBASIN
	PROPOSED SANITARY SERVICE CLEANOUT
	EXISTING SANITARY SERVICE CLEANOUT
	PROPOSED CURB STOP VALVE
	EXISTING CURB STOP VALVE
	EXISTING UNDERGROUND TELEPHONE CABLE
	EXISTING UNDERGROUND GAS LINE
	EXISTING UNDERGROUND HYDRO CABLE

CAUTION:
THE POSITION OF POLE LINES, CONDUITS, WATERMANS, SEWERS AND OTHER UNDERGROUND AND OVERGROUND UTILITIES AND STRUCTURES IS NOT NECESSARILY SHOWN ON THE CONTRACT DRAWINGS, AND, WHERE SHOWN, THE ACCURACY OF THE POSITION OF SUCH UTILITIES AND STRUCTURES IS NOT GUARANTEED. BEFORE STARTING WORK, THE CONTRACTOR SHALL INFORM HIMSELF OF THE EXACT LOCATION OF ALL SUCH UTILITIES AND STRUCTURES, AND SHALL ASSUME ALL LIABILITY FOR DAMAGE TO THEM.

2026-01-27	ISSUED FOR TENDER
2025-11-25	FOR PRELIMINARY REVIEW
DATE	DESCRIPTION
	REVISION / ISSUE

Seal not valid unless signed and dated



Title:
**BRUCE ROAD 9
PULVERIZE & PAVE
STA. 2+031 TO 2+464**

Client: CORPORATION OF THE COUNTY OF BRUCE	
Design: KNK	Scale: 1:200
Drawn: KNK	Approved:
Checked: RME	
Date: 2026-01-27	Design Engineer
DRAWING No. PP08	

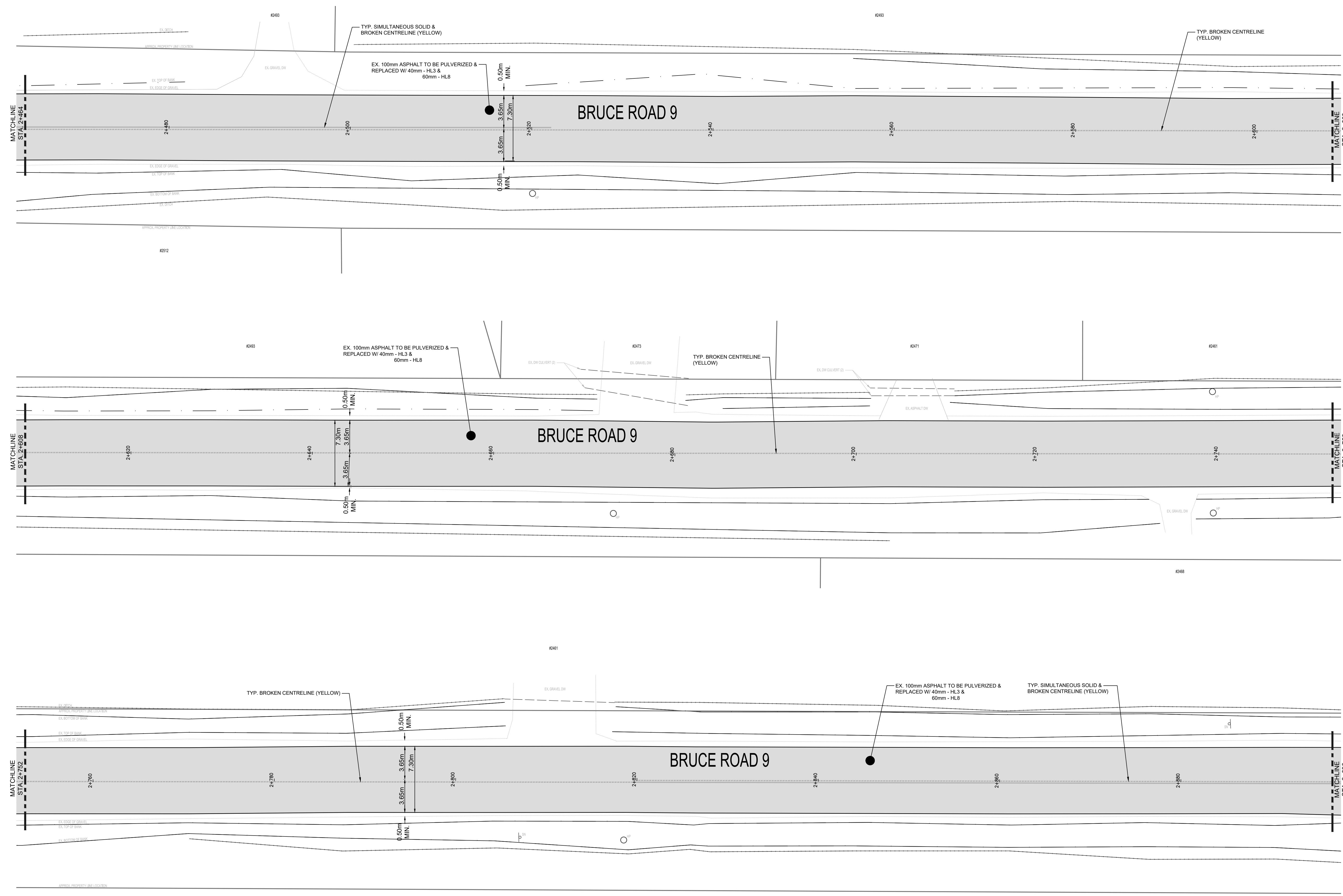
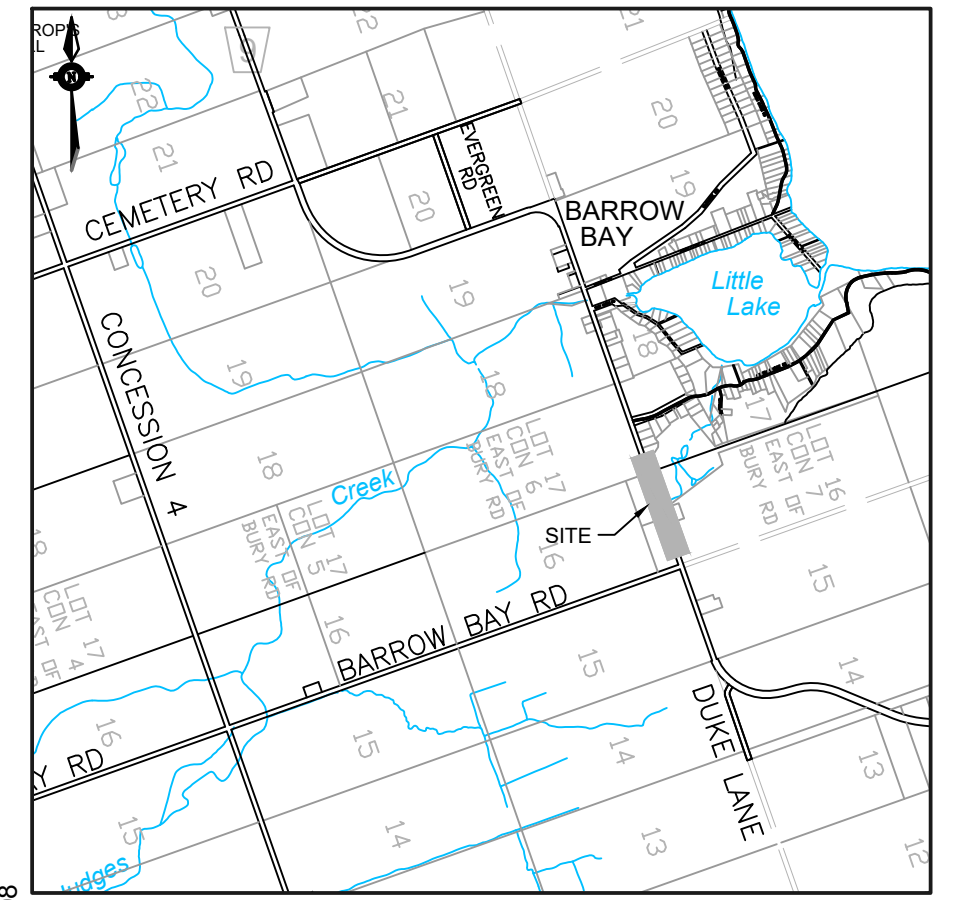
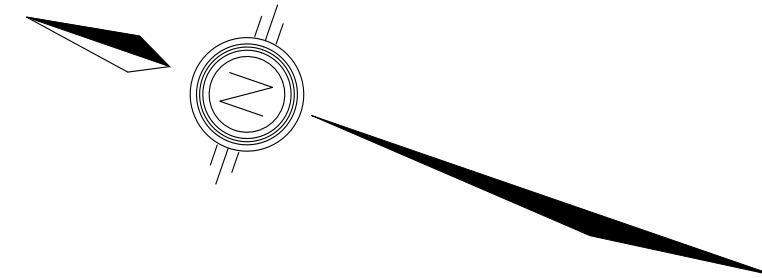

**BRUCE COUNTY
KEY PLAN
NTS**

LEGEND

	TREE REMOVAL AND OR TREE TRIMMING REQUIRED
	PROPOSED SANITARY SEWER
	EXISTING SANITARY SEWER
	PROPOSED STORM SEWER
	EXISTING STORM SEWER
	EXISTING WATERMAIN
	PROPOSED SANITARY SERVICE
	PROPOSED WATER SERVICE
	PROPOSED SANITARY MANHOLE
	EXISTING SANITARY MANHOLE
	PROPOSED CATCHBASIN MANHOLE
	PROPOSED DOUBLE CATCHBASIN MANHOLE
	PROPOSED DOUBLE CATCHBASIN
	PROPOSED CATCH BASIN
	EXISTING CATCH BASIN
	PROPOSED DITCH INLET CATCHBASIN
	PROPOSED SANITARY SERVICE CLEANOUT
	PROPOSED CURB STOP VALVE
	EXISTING UNDERGROUND TELEPHONE CABLE
	EXISTING UNDERGROUND GAS LINE
	EXISTING UNDERGROUND HYDRO CABLE

CAUTION :
THE POSITION OF POLE LINES, CONDUITS, WATERMANS, SEWERS AND OTHER UNDERGROUND AND OVERGROUND UTILITIES AND STRUCTURES IS NOT NECESSARILY SHOWN ON THE CONTRACT DRAWINGS, AND, WHERE SHOWN, THE ACCURACY OF THE POSITION OF SUCH UTILITIES AND STRUCTURES IS NOT GUARANTEED. BEFORE STARTING WORK, THE CONTRACTOR SHALL INFORM HIMSELF OF THE EXACT LOCATION OF ALL SUCH UTILITIES AND STRUCTURES, AND SHALL ASSUME ALL LIABILITY FOR DAMAGE TO THEM.

2026-01-27	ISSUED FOR TENDER
2025-11-25	FOR PRELIMINARY REVIEW
DATE	DESCRIPTION
	REVISION / ISSUE

Seal not valid unless signed and dated



Title: **BRUCE ROAD 9
PULVERIZE & PAVE
STA. 2+464 TO 2+896**

Client: **CORPORATION OF THE COUNTY OF BRUCE**

Design: KNK	Scale: 1:200
Drawn: KNK	Approved:
Checked: RME	
Date: 2026-01-27	Design Engineer

DRAWING No. **PP09**

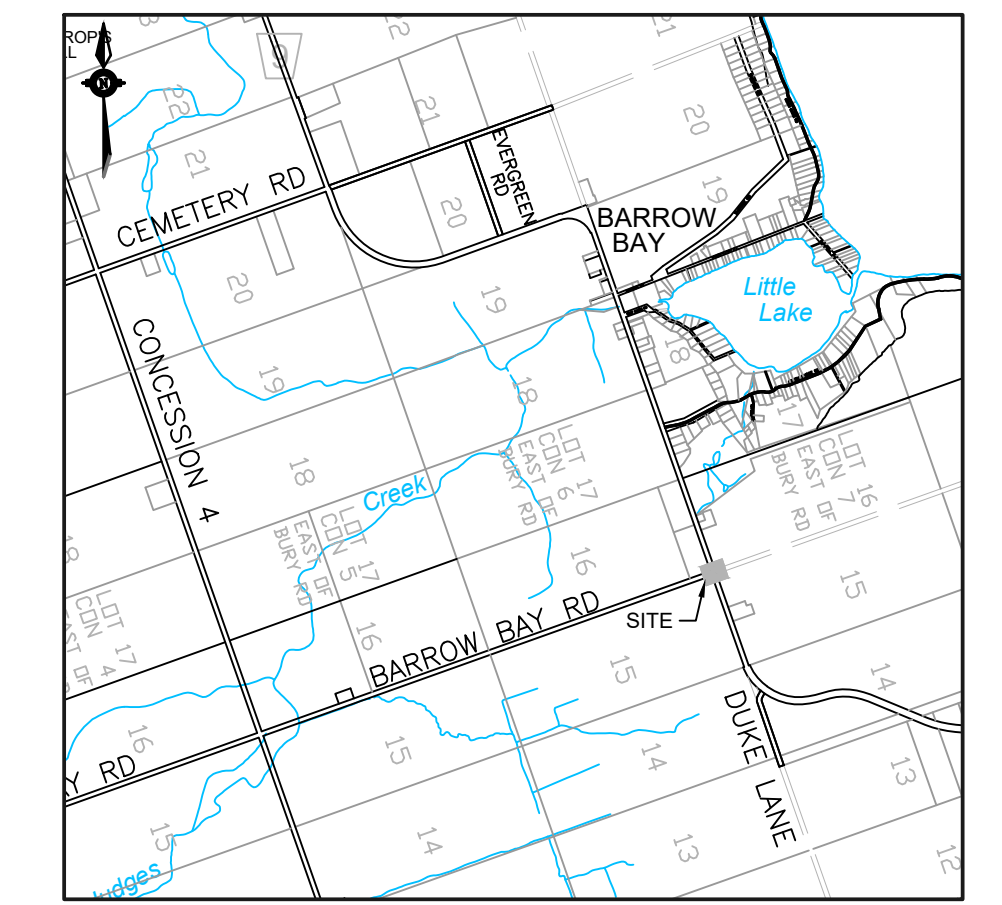
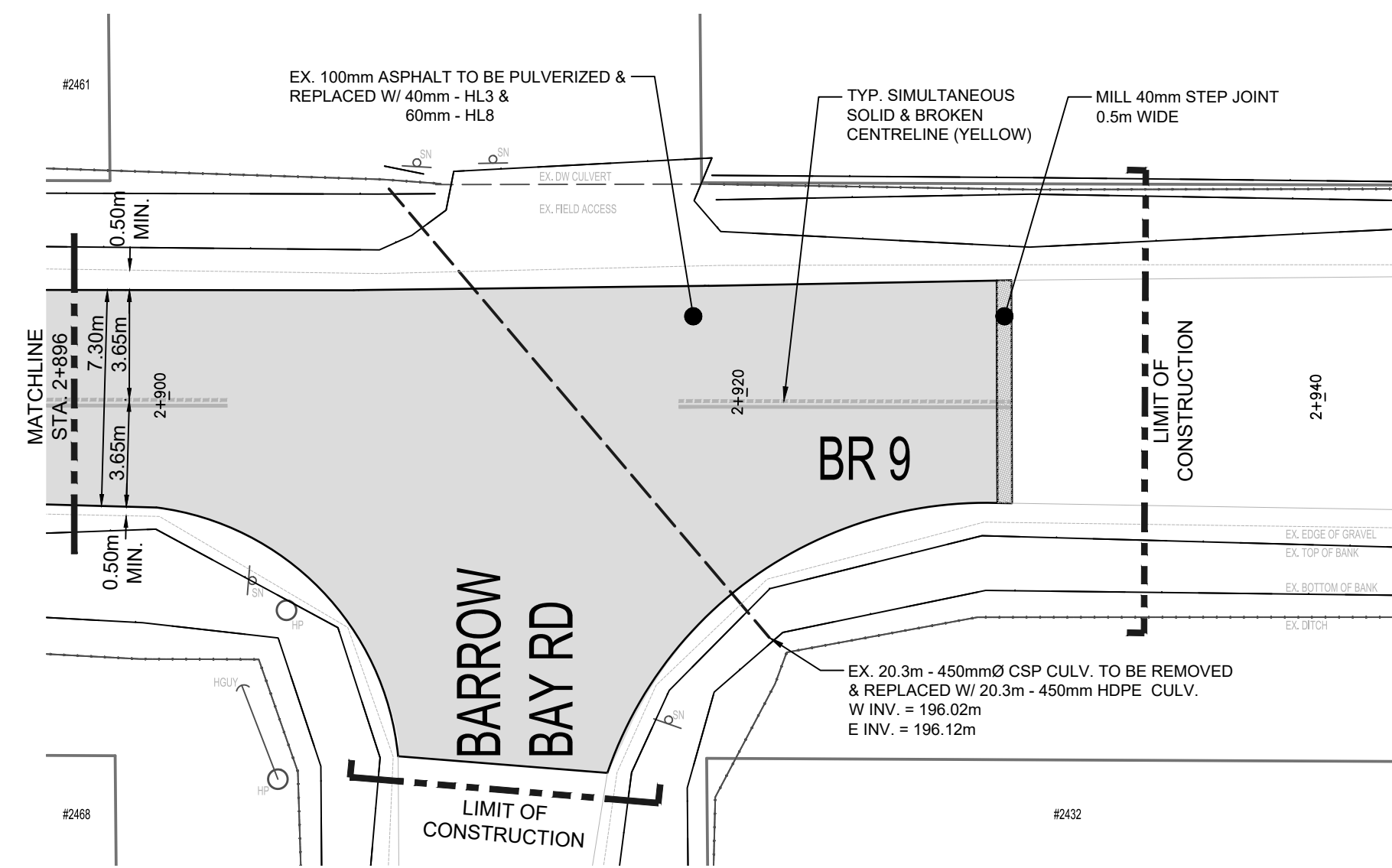
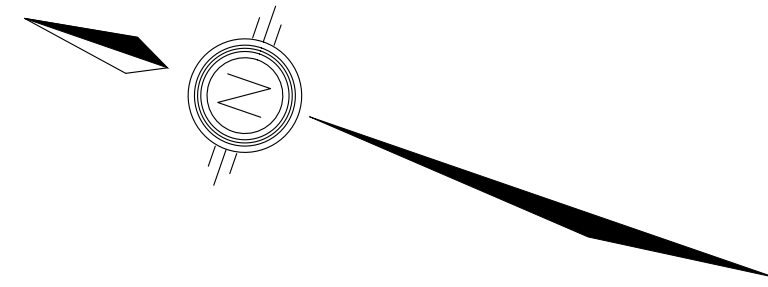

**BRUCE COUNTY
KEY PLAN
NTS**

LEGEND	
	TREE REMOVAL/ AND OR TREE TRIMMING REQUIRED
	PROPOSED SANITARY SEWER
	EXISTING SANITARY SEWER
	PROPOSED STORM SEWER
	EXISTING STORM SEWER
	EXISTING WATERMAIN
	PROPOSED SANITARY SERVICE
	PROPOSED WATER SERVICE
	SAN MH.1 PROPOSED SANITARY MANHOLE
	EXISTING SANITARY MANHOLE
	CBMH PROPOSED CATCHBASIN MANHOLE
	EXISTING CATCHBASIN MANHOLE
	DCBMH PROPOSED DOUBLE CATCHBASIN MANHOLE
	EXISTING DOUBLE CATCHBASIN MANHOLE
	DCB PROPOSED DOUBLE CATCHBASIN
	EXISTING DOUBLE CATCHBASIN
	CB PROPOSED CATCH BASIN
	EXISTING CATCH BASIN
	EX.CB PROPOSED DITCH INLET CATCHBASIN
	EXISTING DITCH INLET CATCHBASIN
	CO PROPOSED SANITARY SERVICE CLEANOUT
	EXISTING SANITARY SERVICE CLEANOUT
	CS PROPOSED CURB STOP VALVE
	EXISTING CURB STOP VALVE
	T EXISTING UNDERGROUND TELEPHONE CABLE
	GAS EXISTING UNDERGROUND GAS LINE
	H EXISTING UNDERGROUND HYDRO CABLE

CAUTION :
THE POSITION OF POLE LINES, CONDUITS, WATERMANS, SEWERS AND OTHER UNDERGROUND AND OVERGROUND UTILITIES AND STRUCTURES IS NOT NECESSARILY SHOWN ON THE CONTRACT DRAWINGS, AND, WHERE SHOWN, THE ACCURACY OF THE POSITION OF SUCH UTILITIES AND STRUCTURES IS NOT GUARANTEED. BEFORE STARTING WORK, THE CONTRACTOR SHALL INFORM HIMSELF OF THE EXACT LOCATION OF ALL SUCH UTILITIES AND STRUCTURES, AND SHALL ASSUME ALL LIABILITY FOR DAMAGE TO THEM.

2026-01-27	ISSUED FOR TENDER
2025-11-25	FOR PRELIMINARY REVIEW
DATE	DESCRIPTION
	REVISION / ISSUE

Seal not valid unless signed and dated



Title:
**BRUCE ROAD 9
PULVERIZE & PAVE
STA. 2+896 TO 2+929**

Client: CORPORATION OF THE COUNTY OF BRUCE	
Design: KNK	Scale: 1:200
Drawn: KNK	Approved:
Checked: RME	
Date: 2026-01-27	Design Engineer
DRAWING No.	PP10

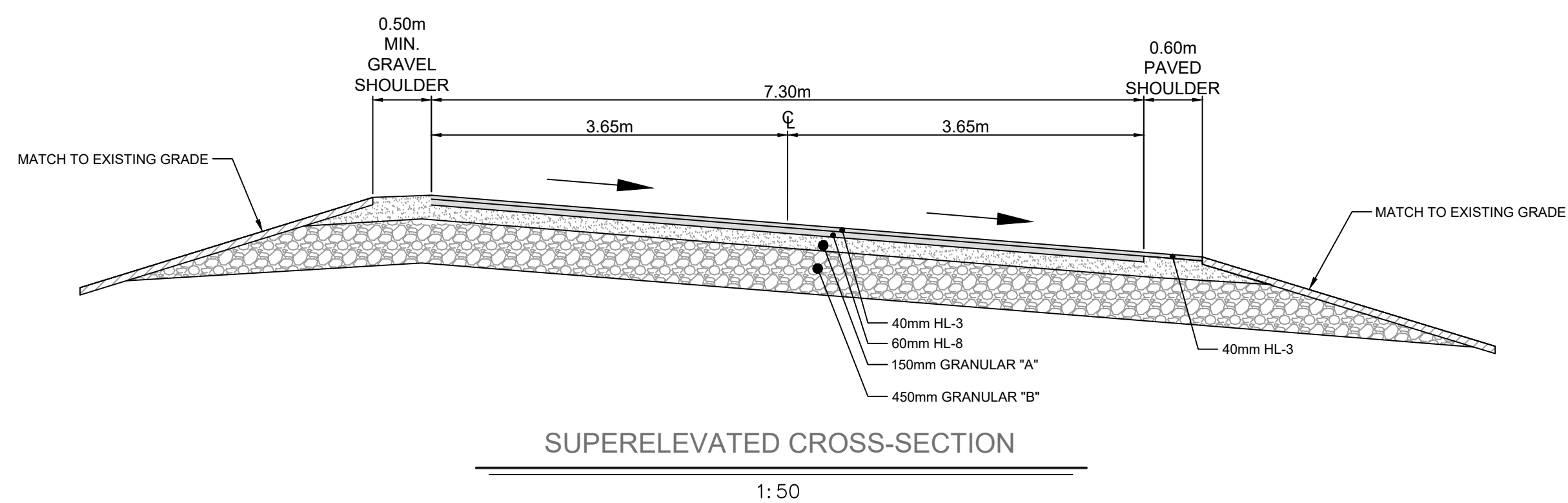
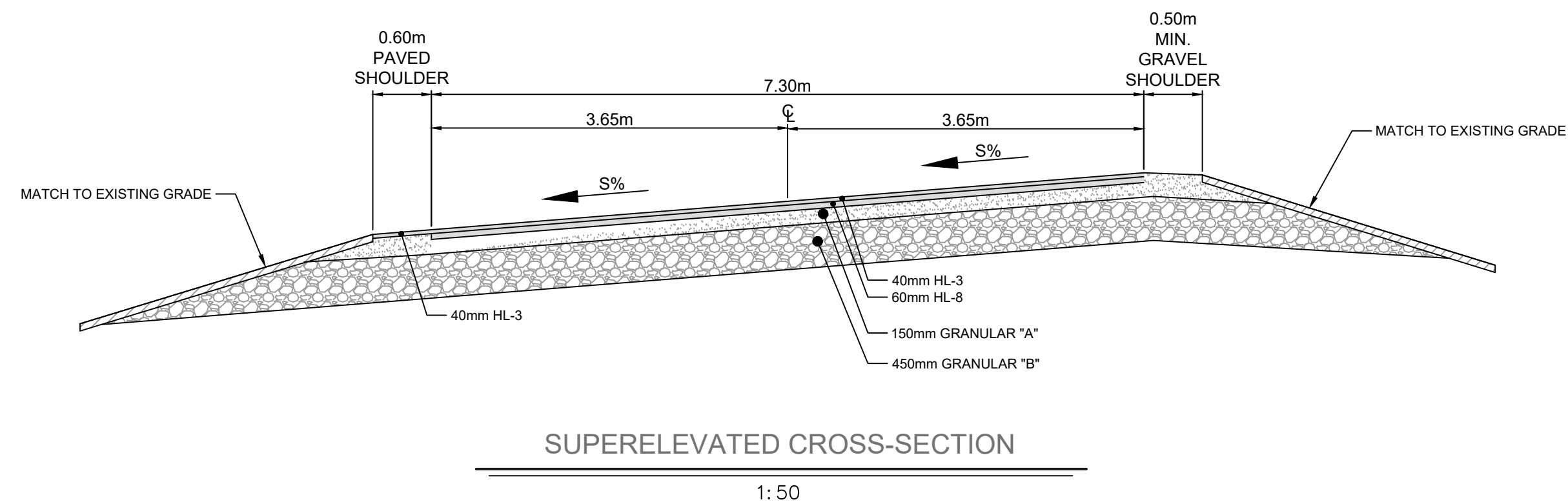
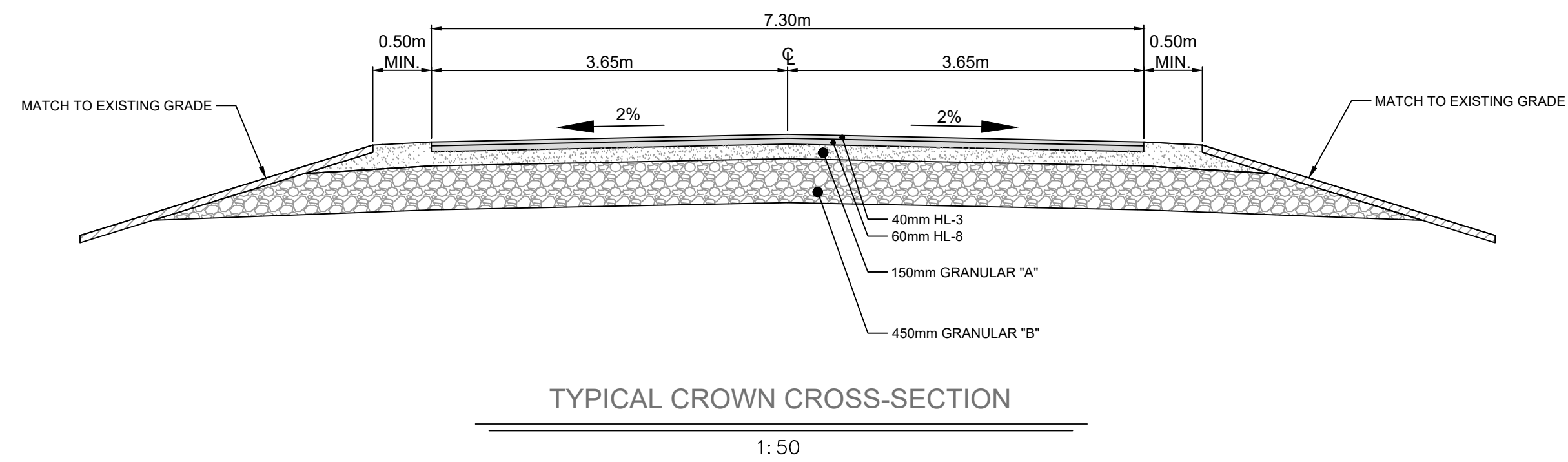

TYP. DOUBLE SOLID CENTRELINE (YELLOW) DETAIL N.T.S

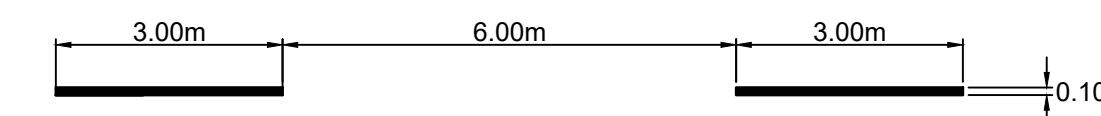

TYP. BROKEN CENTRELINE (YELLOW) DETAIL N.T.S

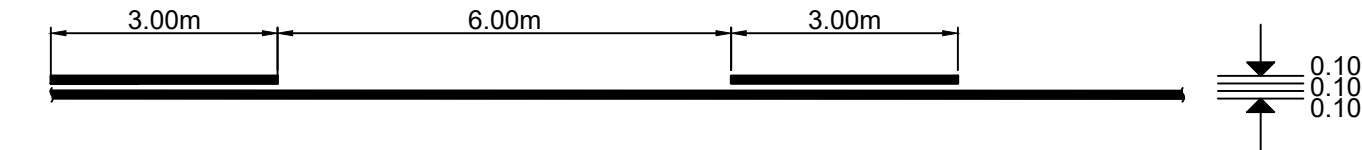

TYP. SIMULTANEOUS SOLID AND BROKEN CENTRELINE (YELLOW) DETAIL N.T.S

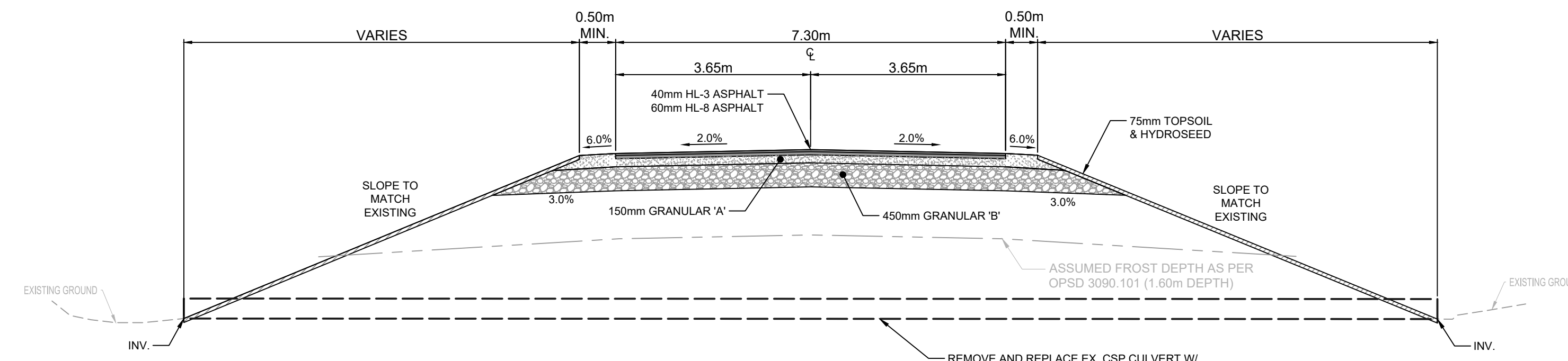

BRUCE ROAD 9 PROPOSED CULVERT CROSS-SECTION

1:75

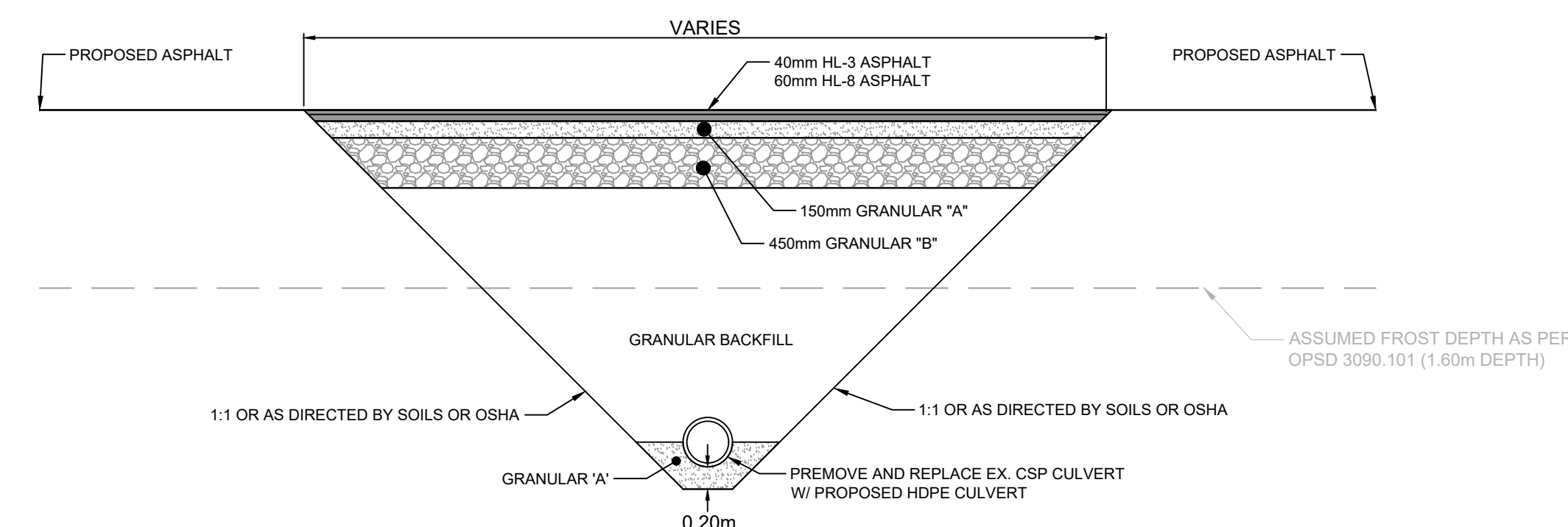

BRUCE ROAD 9 PROPOSED CULVERT CROSS-SECTION

1:50

NOTE: OPSD 803.031 APPLIES. FROST TAPERS BASED ON ASSUMED TYPE 3 SOIL. ADJUST FROST TAPER TO EXISTING SOIL CONDITIONS.

CAUTION :
THE POSITION OF POLE LINES, CONDUITS, WATERMANS, SEWERS AND OTHER UNDERGROUND AND OVERGROUND UTILITIES AND STRUCTURES IS NOT NECESSARILY SHOWN ON THE CONTRACT DRAWINGS, AND, WHERE SHOWN, THE ACCURACY OF THE POSITION OF SUCH UTILITIES AND STRUCTURES IS NOT GUARANTEED. BEFORE STARTING WORK, THE CONTRACTOR SHALL INFORM HIMSELF OF THE EXACT LOCATION OF ALL SUCH UTILITIES AND STRUCTURES, AND SHALL ASSUME ALL LIABILITY FOR DAMAGE TO THEM.

2026-01-27	ISSUED FOR TENDER
2025-11-25	FOR PRELIMINARY REVIEW
DATE	DESCRIPTION
	REVISION / ISSUE

Seal not valid unless signed and dated



Title: BRUCE ROAD 9 PULVERIZE & PAVE TYPICAL SECTIONS & DETAILS 01

Client: CORPORATION OF THE COUNTY OF BRUCE	
Design: KNK	Scale: AS SHOWN
Drawn: KNK	Approved:
Checked: RME	
Date: 2026-01-27	Design Engineer
DRAWING No. PP11	

STA.	WEST/SOUTH SLOPE %	℄ ELEV.	EAST/ NORTH SLOPE %
0+027	1.5	209.76	2.0
0+040	2.0	209.92	2.0
0+050	1.3	209.82	5.1
0+060	1.0	209.63	1.3
0+070	1.5	209.62	4.2
0+080	1.5	209.61	2.9
0+090	0.1	209.59	2.4
0+100	0.6	209.57	3.1
0+110	0.0	209.53	3.7
0+120	-1.67	209.47	3.9
0+130	-1.0	209.49	6.4
0+140	-0.5	209.51	8.2
0+150	-2.7	209.44	10.1
0+160	-4.0	209.39	10.9
0+170	-5.2	209.30	10.8
0+180	-5.9	209.27	10.4
0+190	-6.9	209.23	9.6
0+200	-8.4	209.14	8.7
0+210	-6.6	209.13	10.9
0+220	-6.0	209.07	11.0
0+230	-5.5	209.00	10.6
0+240	-5.5	208.95	9.9
0+250	-4.9	208.91	9.1
0+260	-4.3	208.89	9.2
0+270	-4.1	208.87	8.7
0+280	-3.8	208.84	8.5
0+290	-4.1	208.79	8.3
0+300	-4.6	208.71	7.6
0+310	-4.2	208.61	6.8
0+320	-4.5	208.56	7.7
0+330	-4.6	208.52	8.2
0+340	-4.4	208.49	7.7
0+350	-4.5	208.40	7.8
0+360	-5.1	208.31	8.7
0+370	-5.6	208.21	9.6
0+380	-6.5	208.10	9.9
0+390	-6.2	207.97	8.3
0+400	-6.2	207.89	8.3
0+410	-5.6	207.83	9.4
0+420	-5.4	207.64	9.7
0+430	-4.9	207.46	8.8
0+440	-5.5	207.39	8.9
0+450	-6.0	207.29	9.1
0+460	-6.3	207.19	6.3
0+470	-6.4	207.12	9.9
0+480	-6.3	207.13	12.2
0+490	-6.0	206.98	13.0
0+500	-6.9	206.9	14.5
0+510	-2.9	206.86	16.7
0+520	-8.5	206.24	10.6
0+530	-8.5	206.02	8.8
0+540	-8.4	205.84	6.8
0+550	-6.3	205.68	5.8
0+560	-6.7	205.59	4.5
0+570	-3.7	205.54	4.0

STA.	WEST/ SOUTH SLOPE %	℄ ELEV.	EAST/ NORTH SLOPE %
0+580	-5.1	205.36	3.1
0+590	-6.0	205.16	1.5
0+600	-6.8	205.03	4.8
0+610	-1.9	204.97	6.3
0+620	-0.5	205.01	8.5
0+630	-6.5	205.03	10.8
0+640	-5.8	204.95	10.8
0+650	-5.3	204.87	9.5
0+660	-3.1	204.80	7.8
0+670	-3.3	204.75	6.9
0+680	-1.2	204.72	7.7
0+690	0.0	204.60	8.3
0+700	0.0	204.49	8.4
0+710	1.0	204.36	8.4
0+720	1.9	204.26	8.2
0+730	3.2	204.16	7.8
0+740	2.8	204.05	7.6
0+750	2.5	203.90	7.7
0+760	2.9	203.84	6.7
0+770	4.0	203.73	6.0
0+780	5.0	203.66	6.3
0+790	2.0	203.35	3.9
0+800	3.3	203.00	4.8
0+810	1.8	202.86	1.5
0+820	3.2	202.61	1.0
0+830	0.8	202.21	2.8
0+840	0.5	201.90	1.6
0+850	1.9	201.68	2.0
0+860	3.2	201.37	2.5
0+870	1.9	200.95	1.2
0+880	0.3	200.56	0.2
0+890	0.5	200.19	0.5
0+900	0.9	199.82	0.0
0+910	1.8	199.44	0.8
0+920	1.9	199.08	0.0
0+930	2.1	198.77	2.5
0+940	2.6	198.51	4.4
0+950	2.0	198.27	2.8
0+960	1.4	198.05	2.6
0+970	2.1	197.86	-0.9
0+980	2.3	197.76	2.7
0+990	2.8	197.65	1.3
1+000	2.9	197.60	1.5
1+010	2.6	197.53	0.9
1+020	1.7	197.47	0.5
1+030	2.6	197.45	0.1
1+040	3.8	197.44	0.9
1+050	3.0	197.43	0.8
1+060	2.9	197.44	1.2
1+070	3.3	197.47	2.1
1+080	2.8	197.45	2.7
1+090	2.0	197.39	2.3
1+100	1.5	197.30	0.3
1+110	1.7	197.24	-1.6
1+120	2.2	197.23	-1.4

STA.	WEST/ SOUTH SLOPE %	℄ ELEV.	EAST/ NORTH SLOPE %
1+130	1.5	209.76	12.2
1+140	6.3	209.92	12.4
1+150	1.3	209.82	5.1
1+160	2.4	197.35	0.0
1+170	2.7	197.38	0.9
1+180	2.3	197.37	0.5
1+190	4.2	197.41	0.6
1+200	4.2	197.45	0.3
1+210	4.3	197.44	-1.5
1+220	4.3	197.43	-4.3
1+230	8.2	197.43	-4.3
1+240	10.5	197.47	-2.7
1+250	13.1	197.41	-4.3
1+260	14.1	197.35	-5.6
1+270	11.9	197.29	-6.6
1+280	11.0	197.24	-6.2
1+290	10.4	197.18	-6.9
1+300	10.0	197.18	-4.6
1+310	9.5	197.14	-2.5
1+320	9.9	197.05	-1.2
1+330	11.2	196.85	-1.3
1+340	11.1	196.59	-4.0
1+350	12.1	196.45	-4.1
1+360	12.2	196.23	-5.5
1+370	12.4	196.18	-4.4
1+380	12.4	196.02	-2.1
1+390	12.2	195.92	-3.4
1+400	8.0	195.76	-1.2
1+410	6.1	195.60	0.0
1+420	5.0	195.47	0.1
1+430	4.7	195.33	1.9
1+440	3.4	195.18	2.4
1+450	2.8	195.06	2.4
1+460	3.1	194.94	2.1
1+470	4.7	194.80	1.6
1+480	3.6	194.68	2.0
1+490	4.0	194.56	2.7
1+500	4.8	194.41	2.6
1+510	3.3	194.25	3.1
1+520	2.8	194.25	3.1
1+530	0.5	193.92	0.5
1+540	1.3	193.84	0.2
1+550	1.0	193.72	1.0
1+560	2.9	193.65	1.4
1+570	1.4	193.40	-1.3
1+580	2.3	193.26	-0.9
1+590	2.7	193.13	0.0
1+600	0.5	192.99	-1.3
1+610	0.4	192.93	1.0
1+620	0.5	192.83	3.5
1+630	3.7	192.48	3.8
1+640	4.2	192.10	4.6
1+650	3.5	191.73	3.9
1+660	5.0	191.36	2.1
1+670	4.0	191.09	0.3

STA.	WEST/ SOUTH SLOPE %	℄ ELEV.	EAST/ NORTH SLOPE %
1+680	4.0	190.70	1.5
1+690	2.1	190.73	0.9
1+700	2.1	190.66	1.6
1+710	1.4	190.49	2.2
1+720	0.5	190.46	1.2
1+727	1.7	190.40	1.5
1+742	2.4	190.32	2.0
1+750	-1.95	190.22	2.1
1+760	-2.0	190.06	0.9
1+770	-1.2	190.09	1
1+780	0.3	190.20	2.2
1+790	1.8	190.33	5.5
1+800	1.7	190.36	1.9
1+810 - 2+240	2.0	VARIABLES	2.0
2+250	2.0	200.40	2.3
2+260	2.0	200.50	3.5
2+270	2.0	200.37	3.6
2+280	2.0	200.19	2.0
2+290 - 2+937	2.0	VARIABLES	2.0

CAUTION :
 THE POSITION OF POLE LINES, CONDUITS, WATERMANS, SEWERS AND OTHER UNDERGROUND AND OVERGROUND UTILITIES AND STRUCTURES IS NOT NECESSARILY SHOWN ON THE CONTRACT DRAWINGS, AND, WHERE SHOWN, THE ACCURACY OF THE POSITION OF SUCH UTILITIES AND STRUCTURES IS NOT GUARANTEED. BEFORE STARTING WORK, THE CONTRACTOR SHALL INFORM HIMSELF OF THE EXACT LOCATION OF ALL SUCH UTILITIES AND STRUCTURES, AND SHALL ASSUME ALL LIABILITY FOR DAMAGE TO THEM.

DATE	DESCRIPTION
2026-01-27	ISSUED FOR TENDER
2025-11-25	FOR PRELIMINARY REVIEW
	REVISION / ISSUE

Seal not valid unless signed and dated



BRUCE
county

Title: **BRUCE ROAD 9
PULVERIZE & PAVE
TYPICAL SECTIONS & DETAILS 02**

Client: **CORPORATION OF THE COUNTY OF BRUCE**

Design: KNK	Scale: AS SHOWN
Drawn: KNK	Approved:
Checked: RME	
Date: 2026-01-27	Design Engineer

DRAWING No. **PP12**